

# JVC



## CD/CASSETTE RECEIVER

## KW-XC410/KW-XC400

ENGLISH

## RECEPTOR CON CD/CASSETTE KW-XC410/KW-XC400

ESPAÑOL

## RECEPTEUR CD/CASSETTE

## KW-XC410/KW-XC400

FRANÇAIS

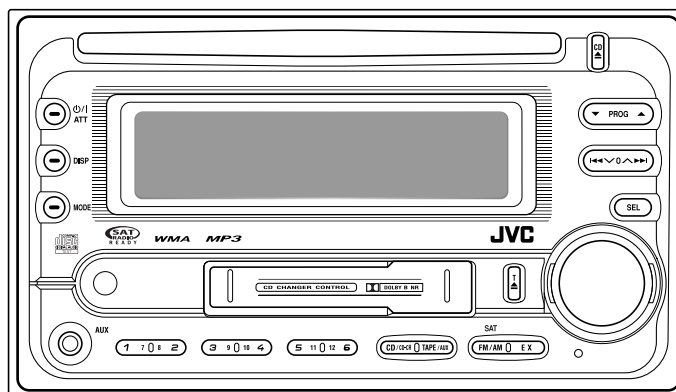
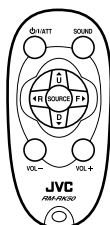

For canceling the display demonstration, see page 8.

Para cancelar la demostración en pantalla, consulte la página 8.

Pour annuler la démonstration des affichages, référez-vous à la page 8.

For installation and connections, refer to the separate manual.

Para la instalación y las conexiones, refiérase al manual separado.

Pour l'installation et les raccordements, se référer au manuel séparé.

### For customer Use:

Enter below the Model No. and Serial No. which are located on the top or bottom of the cabinet. Retain this information for future reference.

Model No. \_\_\_\_\_

Serial No. \_\_\_\_\_

# INSTRUCTIONS

## MANUAL DE INSTRUCCIONES

## MANUEL D'INSTRUCTIONS

GET0320-001B

[J]

Thank you for purchasing a JVC product.

Please read all instructions carefully before operation, to ensure your complete understanding and to obtain the best possible performance from the unit.

### **INFORMATION (For U.S.A.)**

This equipment has been tested and found to comply with the limits for a Class B digital device, pursuant to Part 15 of the FCC Rules. These limits are designed to provide reasonable protection against harmful interference in a residential installation. This equipment generates, uses, and can radiate radio frequency energy and, if not installed and used in accordance with the instructions, may cause harmful interference to radio communications. However, there is no guarantee that interference will not occur in a particular installation. If this equipment does cause harmful interference to radio or television reception, which can be determined by turning the equipment off and on, the user is encouraged to try to correct the interference by one or more of the following measures:

- Reorient or relocate the receiving antenna.
- Increase the separation between the equipment and receiver.
- Connect the equipment into an outlet on a circuit different from that to which the receiver is connected.
- Consult the dealer or an experienced radio/TV technician for help.

### **IMPORTANT FOR LASER PRODUCTS**

1. CLASS 1 LASER PRODUCT
2. **CAUTION:** Do not open the top cover. There are no user serviceable parts inside the unit; leave all servicing to qualified service personnel.
3. **CAUTION:** Visible and invisible laser radiation when open and interlock failed or defeated. Avoid direct exposure to beam.

#### **Warning:**

If you need to operate the unit while driving, be sure to look ahead carefully or you may be involved in a traffic accident.

#### **Caution on volume setting:**

Discs produce very little noise compared with other sources. Lower the volume before playing a disc to avoid damaging the speakers by the sudden increase of the output level.

### **How to reset your unit**

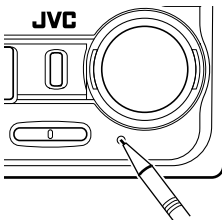

*This will reset the microcomputer. Your preset adjustments will also be erased.*

### **How to forcibly eject a disc**

If a disc cannot be recognized or cannot be ejected, eject the disc as follows.

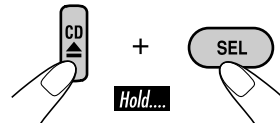

- If this does not work, reset your unit.
- Be careful not to drop the disc when it ejects.

# Contents

How to reset your unit .....	2	<b>Tape operations .....</b>	<b>17</b>
How to forcibly eject a disc .....	2	<b>Playing a tape.....</b>	<b>17</b>
How to read this manual .....	4	Finding the beginning of a tune .....	17
How to use the MODE button .....	4	Other convenient tape functions .....	17
<b>Control panel —</b>		<b>Sound adjustments .....</b>	<b>18</b>
<b>KW-XC410/KW-XC400.....</b>	<b>5</b>	<b>Selecting preset sound modes</b>	
Parts identification .....	5	<b>(EQ: equalizer).....</b>	<b>18</b>
<b>Remote controller — RM-RK50 ...</b>	<b>6</b>	Adjusting the sound .....	18
Main elements and features .....	6	Storing your own sound adjustments.....	19
<b>Getting started.....</b>	<b>7</b>	<b>General settings — PSM .....</b>	<b>20</b>
<b>Basic operations.....</b>	<b>7</b>	Basic procedure .....	20
Canceling the display demonstrations ...	8	<b>External component operations... 23</b>	
Setting the clock .....	8	<b>Playing an external component .....</b>	<b>23</b>
<b>Radio operations .....</b>	<b>9</b>	<b>Satellite radio operations .....</b>	<b>24</b>
<b>Listening to the radio.....</b>	<b>9</b>	Listening to the SIRIUS Satellite radio... 25	
Storing stations in memory .....	9	Listening to the XM Satellite radio .....	25
Listening to a preset station .....	10	Storing channels in memory .....	26
Scanning broadcast stations.....	10	Listening to a preset channel .....	26
Assigning titles to the stations .....	11	<b>Maintenance .....</b>	<b>27</b>
<b>Disc operations .....</b>	<b>12</b>	Handling discs .....	27
<b>Playing a disc in the unit .....</b>	<b>12</b>	Handling cassettes .....	27
<b>Playing discs in the CD changer .....</b>	<b>13</b>	<b>More about this unit.....</b>	<b>28</b>
Other main functions .....	15	<b>Troubleshooting .....</b>	<b>31</b>
Changing the display information .....	15	<b>Specifications .....</b>	<b>33</b>
Selecting the playback modes.....	16		

## For safety....

- Do not raise the volume level too much, as this will block outside sounds, making driving dangerous.
- Stop the car before performing any complicated operations.



## Temperature inside the car....

If you have parked the car for a long time in hot or cold weather, wait until the temperature in the car becomes normal before operating the unit.

## How to read this manual

The following methods are used to make the explanations simple and easy-to-understand:

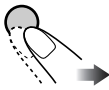
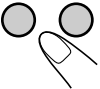
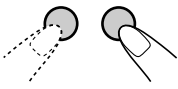
- Some related tips and notes are explained in “More about this unit” (see pages 28 – 30).
- Button operations are mainly explained with the illustrations as follows:

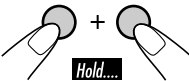
	Press briefly.
	Press repeatedly.
	Press either one.
	
	Press and hold until your desired response begins.
	Press and hold both buttons at the same time.

The following marks are used to indicate...



: Built-in CD player operations.



: External CD changer operations.

This unit is equipped with the steering wheel remote control function.

- See the Installation/Connection Manual (separate volume) for connection.

## How to use the MODE button

Press MODE repeatedly to select the different functions available during play.

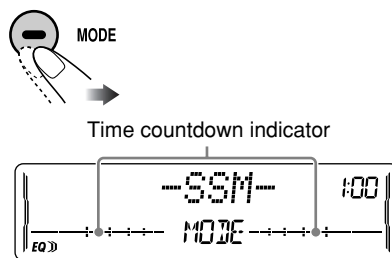

Ex.: When “SSM” is selected

### While listening to the radio:

- You cannot select “SSM” or “SCAN” if you are listening to the station stored in the EX (extra) button, see page 10 for details.

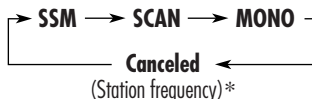

### While listening to a disc:



### While listening to a tape:



### While adjusting the sound mode:

- Pressing MODE allows you to store the adjusted sound mode into memory. (See page 19 for details.)

\* Depending on the level meter setting. (See page 20 for details.)

## Parts identification

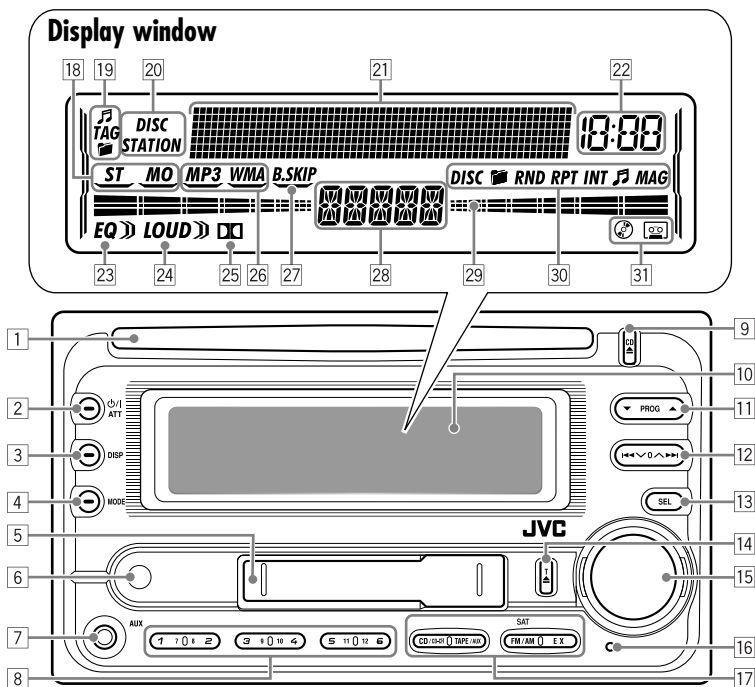

- 1 Loading slot
- 2  $\phi$ /I ATT (standby/on attenuator) button
- 3 DISP (display) button
- 4 MODE button
- 5 Cassette compartment
- 6 Remote sensor
  - **DO NOT** expose the remote sensor to strong light (direct sunlight or artificial lighting).
- 7 AUX (auxiliary) input jack
- 8 Number buttons
- 9 CD  $\blacktriangle$  (CD eject) button
- 10 Display window
- 11  $\blacktriangle$  (up) /  $\blacktriangledown$  (down) buttons  
PROG (program)  $\blacktriangle$  /  $\blacktriangledown$  buttons
- 12  $\blacktriangle\blacktriangle\blacktriangle$  /  $\blacktriangledown$  /  $\blacktriangle\blacktriangle\blacktriangle$  buttons
- 13 SEL (select) button
- 14 T  $\blacktriangle$  (tape eject) button
- 15 Control dial
- 16 Reset button
- 17 Source buttons—CD/CD-CH, TAPE/AUX, FM/AM SAT (satellite), EX (extra)

### Display window

- 18 Tuner reception indicators—ST (stereo), MO (monaural)
- 19 Disc information indicators— $\text{♪}$  (track/file), TAG (ID3 Tag),  $\text{📁}$  (folder)
- 20 Text name indicators—DISC, STATION
- 21 Main display, level meter
- 22 Clock indicator
- 23 EQ (equalizer) indicator
- 24 LOUD (loudness) indicator
- 25  $\text{DB NR}$  (Dolby B NR) indicator
- 26 Playback disc indicators—MP3, WMA
- 27 B.SKIP (blank skip) indicator
- 28 Source display
- 29 Level meter, volume meter, time countdown indicator
- 30 Playback mode indicators—DISC,  $\text{📁}$  (folder), RND (random), RPT (repeat), INT (intro),  $\text{♪}$  (track/file), MAG (magazine)
- 31 Loaded source indicators— $\text{📀}$  (disc),  $\text{📼}$  (tape)

# Remote controller — RM-RK50

## Installing the lithium coin battery (CR2025)

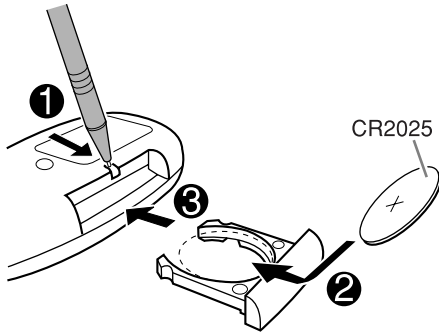

- When operating, aim the remote controller directly at the remote sensor on the unit. Make sure there is no obstacle in between.

### Warning:

- Do not install any battery other than CR2025 or its equivalent; otherwise, it may explode.
- Store the battery in a place where children cannot reach to avoid risk of accident.
- To prevent the battery from over-heating, cracking, or starting a fire:
  - Do not recharge, short, disassemble, heat the battery, or dispose of it in a fire.
  - Do not leave the battery with other metallic materials.
  - Do not poke the battery with tweezers or similar tools.
  - Wrap the battery with tape and insulate when throwing away or saving it.

### Caution:

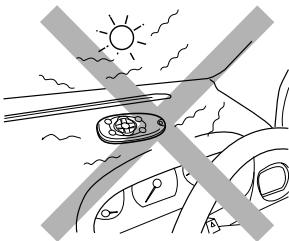

## Main elements and features

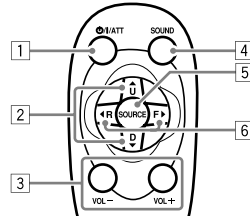

- 1** **⏻/I/ATT** (standby/on/attenuator) button
  - Turns the power on if pressed briefly or attenuates the sound when the power is on.
  - Turns the power off if pressed and held.
- 2** **▲ U** (up) / **D** (down) **▼** buttons
  - Changes the FM/AM bands with **▲ U** only.
  - Changes the preset stations with **D ▼** only.
  - Changes the folder of the MP3/WMA discs.
  - Changes the tape directions with **▲ U** only.
  - While playing an MP3 disc on an MP3-compatible CD changer:
    - Changes the disc if pressed briefly.
    - Changes the folder if pressed and held.
  - While listening to the satellite (SIRIUS or XM) radio:
    - Changes the categories.
- 3** **VOL - / VOL +** buttons
  - Adjusts the volume level.
- 4** **SOUND** button
  - Selects the sound mode (EQ: equalizer).
- 5** **SOURCE** button
  - Selects the source.
- 6** **◀ R** (reverse) / **F** (forward) **▶** buttons
  - Searches for stations if pressed briefly.
  - Fast-forwards or reverses the track if pressed and held.
  - Changes the tracks of the disc if pressed briefly.
  - Fast-forwards or reverses the tape if pressed and held.\*
  - Finds the beginning of a tune (MMS) while listening to a tape if pressed briefly.\*
  - While listening to the satellite radio:
    - Changes the channels if pressed briefly.
    - Changes the channels rapidly if pressed and held.

\* To release these operations, press **▲ U**. Playback resumes.

# Getting started

## Basic operations

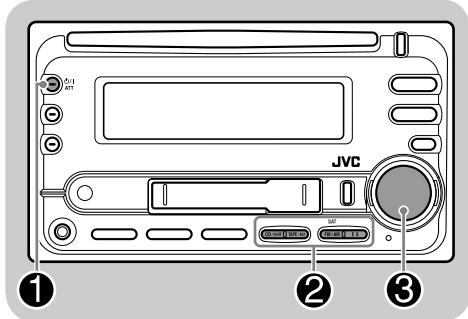

### For your favorite station



- Stored your favorite station, see page 10 for details.

### For CD/CD-CH



### For TAPE/AUX

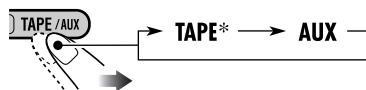

- Select “CD-CH” when using an Apple iPod® or a JVC D. player (see page 23).

iPod is a trademark of Apple Computer, Inc., registered in the U.S. and other countries.

\* You cannot select these sources if they are not ready or not connected.

### 1 Turn on the power.



### 2 For FM/AM tuner



### For SIRIUS Satellite radio\*

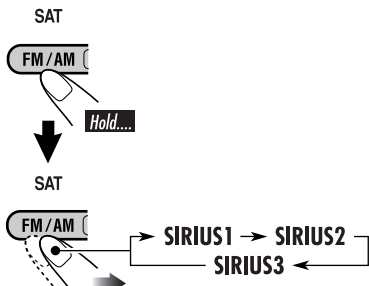

### For XM Satellite radio\*

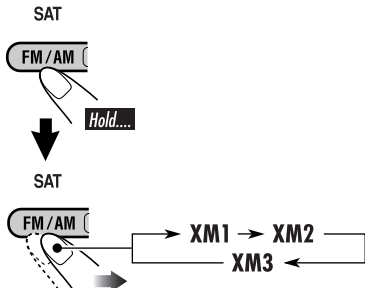

### 3 Adjust the volume.

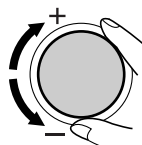

Volume level appears.

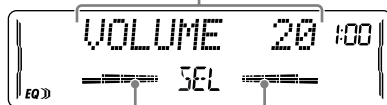

Volume level indicator

### 4 Adjust the sound as you want. (See pages 18 and 19.)

### To drop the volume in a moment (ATT)



To restore the sound, press it again.

### To turn off the power



## Canceling the display demonstrations

If no operations are done for about 20 seconds, display demonstration starts.

[Initial: DEMO ON]—see page 20.

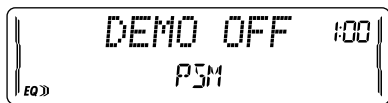
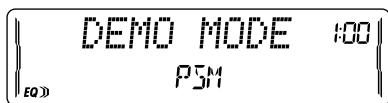
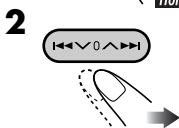
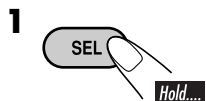

### 4 Finish the procedure.



### To activate the display demonstration

In step 3 above...



## Setting the clock



- 2 Set the hour and minute.
- 1 Select “CLOCK HOUR,” then adjust the hour.
  - 2 Select “CLOCK MIN,” (minute) then adjust the minute.

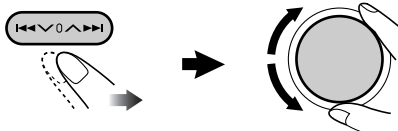

### 3 Finish the procedure.





# Radio operations

## Listening to the radio

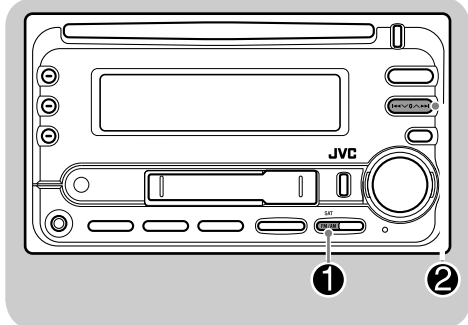

**1** SAT

Lights up when receiving an FM stereo broadcast with sufficient signal strength.

Selected band appears.

**2** Start searching for a station.

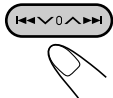

When a station is received, searching stops.

To stop searching, press the same button again.

### To tune in to a station manually

In step 2 above...

**1**

Hold...

**2** Select the desired station frequencies.

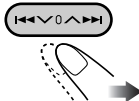

### When an FM stereo broadcast is hard to receive

**1**

**2**

Lights up when monaural mode is activated.



Reception improves, but stereo effect will be lost.

To restore the stereo effect, repeat the same procedure. Then, in step 2, select “MONO OFF.”

## Storing stations in memory

You can preset six stations for each band.

### FM station automatic presetting—SSM (Strong-station Sequential Memory)

**1** Select the FM band (FM1 – FM3) you want to store into.

SAT

To be continued....

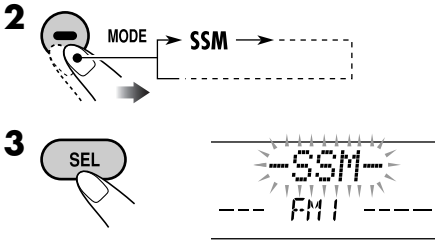

“SSM” flashes, then disappears when automatic presetting is over.

Local FM stations with the strongest signals are searched and stored automatically in the FM band.

### Manual presetting

Ex.: Storing FM station of 92.5 MHz into the preset number 4 of the FM1 band.

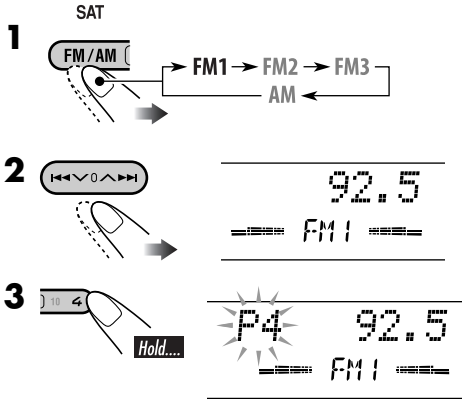

Preset number flashes for a while.

### Storing your favorite station into the EX (extra) button

Ex.: Storing your favorite FM station of 92.5 MHz into the EX button

While listening to an FM station, tune in to your favorite station, then....



### Listening to a preset station

- 1 Press the MODE button to enter 'FM/AM' mode. The display shows 'FM1', 'FM2', 'FM3', and 'AM'.
- 2 Select the preset station (1 – 6) you want.



or



### To tune in to your favorite station (EX)



If you press the button again, the previous source will be played back again.

### Scanning broadcast stations

- 1 Press the MODE button to enter 'SCAN' mode.
- 2 Start scanning. The display shows 'SCAN 92.5' and 'FM1'.

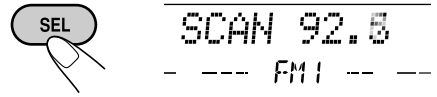

Each time a broadcast is tuned in, scanning stops for about 5 seconds (tuned frequency appears on the display), and you can check what program is now being broadcast.

- 3 Start listening to the program.

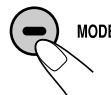

## Assigning titles to the stations

You can assign titles to 30 station frequencies (including both FM and AM). Each station name can be assigned up to 10 characters. However, you cannot assign title to the station frequency stored in the EX button.

- 1 Tune in to the station you would like to assign a title to.
- 2 Enter the assigning mode.

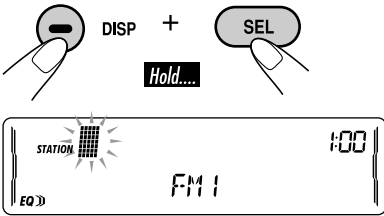

### 3 Assign a title.

- 1 Select a character set.

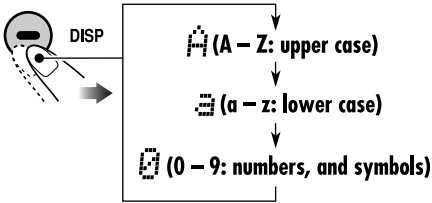

- 2 Select a character.

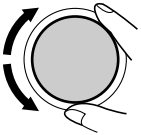

- 3 Move to the next (or previous) character position.

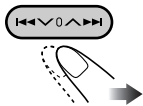

- 4 Repeat steps 1 to 3 until you finish entering the title.

- 4 Finish the procedure.



### To erase the entire title

In step 3 on the left...

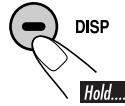

### To change the information shown on the display

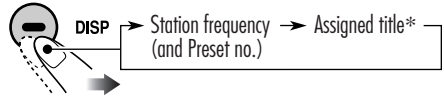

\* If no title is assigned, "NO NAME" appears for a while.

### Available characters

Upper case

A	B	C	D	E	F	G	H	I	J	K	L	M	N
O	P	Q	R	S	T	U	V	W	X	Y	Z	space	

Lower case

a	b	c	d	e	f	g	h	i	j	k	l	m	n
o	p	q	r	s	t	u	v	w	x	y	z	space	

Numbers and symbols

0	1	2	3	4	5	6	7	8	9	!	"	#	\$
%	&	'	(	)	*	+	,	-	.	/	:	;	<
=	>	?	@	_	^	space							

# Disc operations

## Playing a disc in the unit

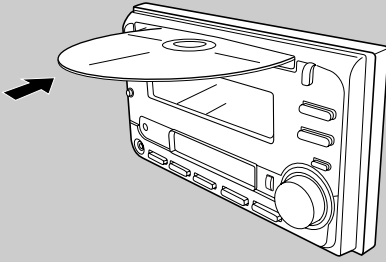

All tracks will be played repeatedly until you change the source or eject the disc.

- When inserting an MP3 or a WMA disc:



Total folder number      Total file number

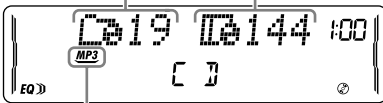

\*1

**Disc information appears automatically (see page 15).**

Current track number\*2      Elapsed playing time\*2

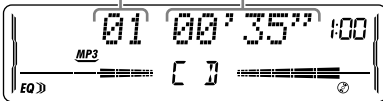

- When inserting an audio CD or a CD Text disc:

Total track number of the inserted disc      Total playing time of the inserted disc

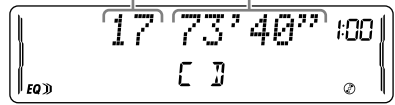

**CD Text: Disc title/performer →  
Track title appears automatically (see page 15).**

Current track number\*2      Elapsed playing time\*2

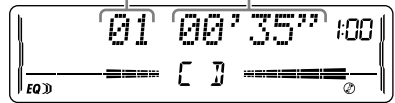

### To stop play and eject the disc



The source changes to the last selected source.

\*1 Either the MP3 or WMA indicator lights up depending on the detected file.

\*2 Depending on the level meter setting. (See page 20 for details.)

## Playing discs in the CD changer

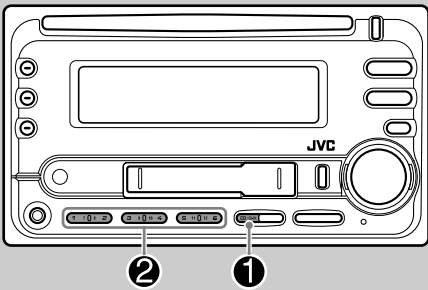

### About the CD changer

It is recommended to use a JVC MP3-compatible CD changer with your unit.

- You can also connect other CH-X series CD changers (except CH-X99 and CH-X100). However, they are not compatible with MP3 discs, so you cannot play back MP3 discs.
- You cannot play any WMA disc in the CD changer.
- You cannot use the KD-MK series CD changers with this unit.
- Disc text information recorded in the CD Text can be displayed when a JVC CD Text compatible CD changer is connected.

For connection, see Installation/Connection Manual (separate volume).

- All disc in the magazine will be played repeatedly until you change the source.
- Ejecting the magazine will also stop playing.

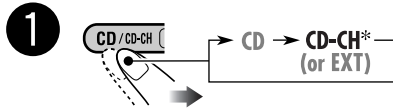

\* If you have changed "EXT INPUT" setting to "EXT INPUT" (see page 22), you cannot select the CD changer.

### 2 Select a disc.

For disc number from 01 – 06:

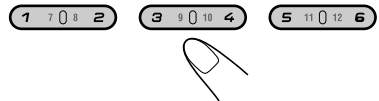

For disc number from 07 – 12:

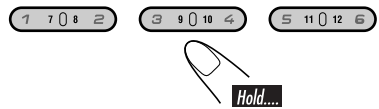

Selected disc number

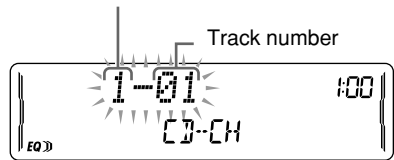

- When the current disc is an MP3 disc:

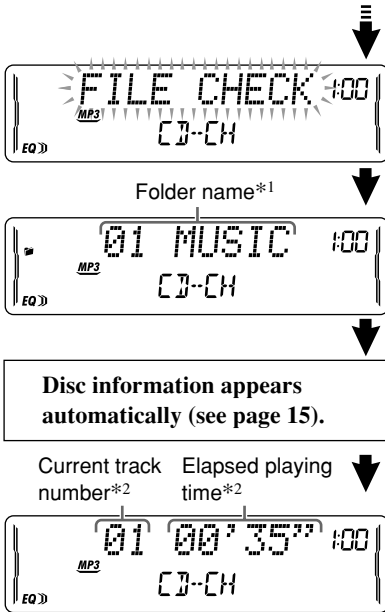

- When the current disc is an audio CD or a CD Text disc:

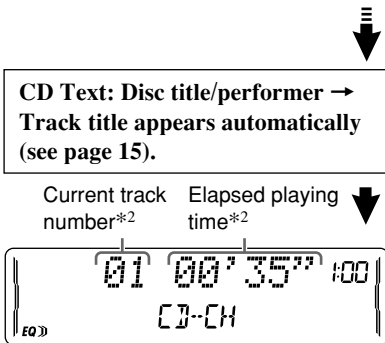

\*1 "ROOT" appears if no folder is included in the disc.

\*2 Depending on the level meter setting. (See page 20 for details.)

### To fast-forward or reverse the track

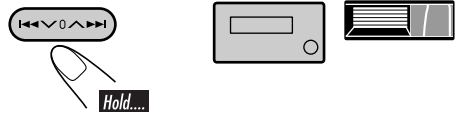

### To go to the next or previous tracks

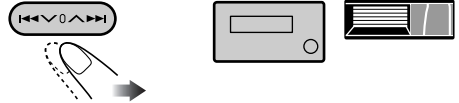

### To go to the next or previous folders for MP3 and WMA discs

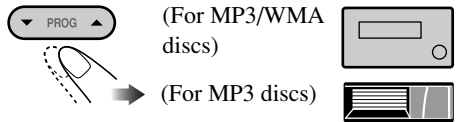

### To locate a particular track (for CD) or folder (for MP3 or WMA discs) directly

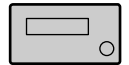

To select a number from 01 – 06:



To select a number from 07 – 12:

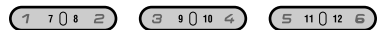

- To use folder search on MP3/WMA discs, it is required that folders are assigned with 2-digit numbers at the beginning of their folder names—01, 02, 03, and so on.

To select a particular track in a folder (for MP3 or WMA disc):

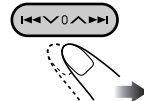

## Other main functions

### ■ Skipping a track quickly during play

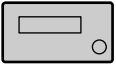

Only possible on JVC  
MP3-compatible CD changer

- For MP3 or WMA disc, you can skip a track within the same folder.

Ex.: To select track 32 while playing track 6

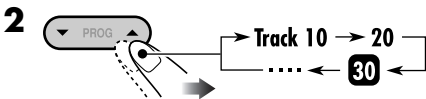
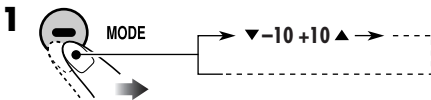

First time you press ▲ / ▼ button, the track skips to the nearest higher or lower track with a track number of multiple ten (ex. 10th, 20th, 30th).

Then each time you press the button, you can skip 10 tracks.

- After the last track, the first track will be selected and vice versa.

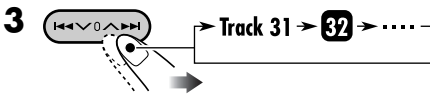

### ■ Prohibiting disc ejection



You can lock a disc in the loading slot.

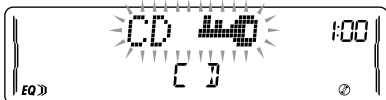

To cancel the prohibition, repeat the same procedure.

## Changing the display information

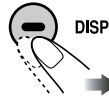

### ■ While playing an audio CD or a CD Text



### ■ While playing an MP3 or a WMA disc

- When “TAG DISP” is set to “TAG ON” (see page 22)

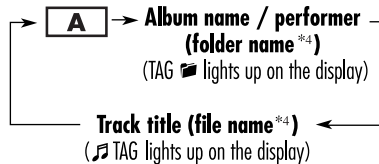

- When “TAG DISP” is set to “TAG OFF”

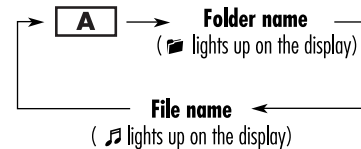

**A** : Current track/file number and Elapsed playing time

\*3 If the current disc is an audio CD, “NO NAME” appears.

\*4 If an MP3/WMA file does not have ID3 tags, folder name and file name appear. In this case, the TAG indicator will not light up.

## Selecting the playback modes

You can use only one of the following playback modes at a time.

Select your desired playback mode.

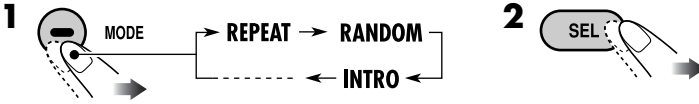

### Repeat play

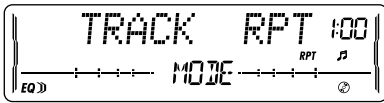

Ex.: When "TRACK RPT" is selected

### Mode

### Plays repeatedly

- TRACK RPT** : The current track.
  - RPT and light up.
- FOLDER RPT**\*1 : All tracks of the current folder.
  - and RPT light up.
- DISC RPT**\*2 : All tracks of the current disc.
  - DISC and RPT light up.
- REPEAT OFF** : Cancels.

### Random play



Ex.: When "DISC RND" is selected

### Mode

### Plays at random

- FOLDER RND**\*1 : All tracks of the current folder, then tracks of the next folder and so on.
  - and RND light up.
- DISC RND** : All tracks of the current disc.
  - DISC and RND light up.
- MAG RND**\*2 : All tracks of the inserted discs.
  - RND and MAG light up.
- RANDOM OFF** : Cancels.

### Intro scan

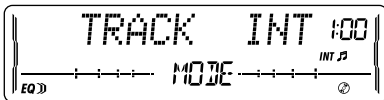

Ex.: When "TRACK INT" is selected

### Mode

### Plays the beginning 15 seconds of...

- TRACK INT** : All tracks of the current disc.
  - INT and light up.
- FOLDER INT**\*1 : The first track of every folder of the current disc.
  - and INT light up.
- DISC INT**\*2 : The first tracks of the inserted discs.
  - DISC and INT light up.
- INTRO OFF** : Cancels.

\*1 Only while playing an MP3 disc or a WMA disc.

\*2 Only while playing discs in the CD changer.



# Tape operations

## Playing a tape

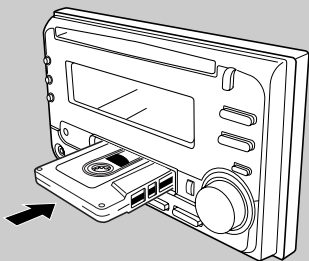

Playback starts automatically. When one side of the tape reaches its end during play, the other side of the tape automatically starts playing. (Auto Reverse)

## To change the playback direction



## To stop play and eject the cassette



The source changes to the last selected source.

## To fast-forward or rewind a tape

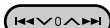

Hold....

When the tape reaches its end while fast-forwarding, the tape direction will change automatically.

To stop fast-forwarding or rewinding, press the PROG button.

## Prohibiting tape ejection

You can lock a tape in the loading slot.



To cancel the prohibition, repeat the same procedure.

## Finding the beginning of a tune

Multi Music Scan (MMS) allows you to automatically start playback from the beginning of a specified tune.

Specify the tune you want to locate (how many tunes ahead of or before the current tune)

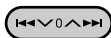

When the beginning of the specified tune is located, playback starts automatically.

MMS -9 <-> MMS -1\*<sup>3</sup>, MMS +1 <-> MMS +9

\*<sup>3</sup> Goes back to the beginning of the current tune.

## Other convenient tape functions

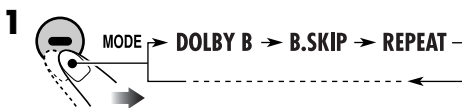

• To turn on or off Dolby B NR\*<sup>4</sup>

DOLBY ON <-> DOLBY OFF  
( lights up on the display)

• To skip blank portions on the tape

B.SKIP ON <-> B.SKIP OFF  
(B.SKIP lights up on the display)

• To play the current tune repeatedly

REPEAT ON <-> REPEAT OFF  
(RPT lights up on the display)

\*<sup>4</sup> Manufactured under license from Dolby Laboratories. "Dolby" and the double-D symbol are trademarks of Dolby Laboratories.

# Sound adjustments

## Selecting preset sound modes (EQ: equalizer)

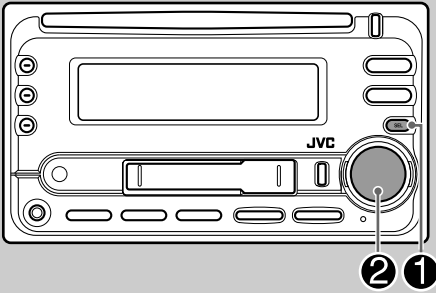

You can select a preset sound mode suitable to the music genre.

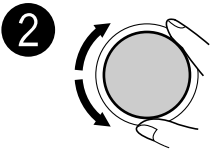
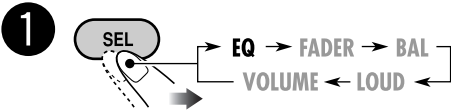

FLAT ⇄ Hard Rock ⇄ R & B ⇄  
 POP ⇄ JAZZ ⇄ DanceMusic ⇄  
 Country ⇄ Reggae ⇄ Classic ⇄  
 USER 1 ⇄ USER 2 ⇄ USER 3 ⇄  
 (back to the beginning)

### To select the sound mode directly

You can select the sound mode directly using the remote controller.

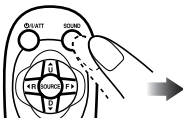

## Adjusting the sound

You can adjust the sound characteristics to your preference.

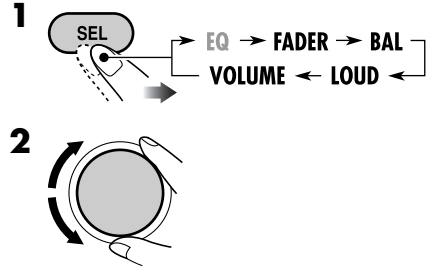

Indication	Range
<b>FADER</b> *1 Adjust the front and rear speaker balance.	R06 (Rear only) to F06 (Front only)
<b>BAL</b> (balance) Adjust the left and right speaker balance.	L06 (Left only) to R06 (Right only)
<b>LOUD</b> (loudness) Boost low and high frequencies to produce a well-balanced sound at low volume level.	LOUD ON ↓ LOUD OFF
<b>VOLUME</b> *2 Adjust the volume.	00 (min.) to 30 or 50 (max.)*3

\*1 If you are using a two-speaker system, set the fader level to "00."

\*2 Normally the control dial works as the volume control. So you do not have to select "VOLUME" to adjust the volume level.

\*3 Depending on the amplifier gain control setting. (See page 22 for details.)

## Storing your own sound adjustments

You can adjust the sound modes and store your own adjustments in memory.

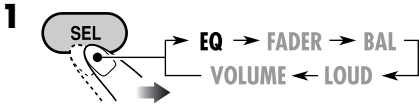

**2** Select one of the sound mode to adjust.

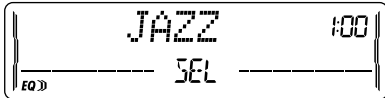
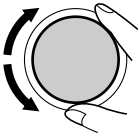

Ex.: When "JAZZ" is selected

**3** Select the sound elements to adjust while the selected sound mode is shown.

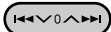

LOW LEVEL ⇄ LOW FREQ. ⇄  
 LOW WIDTH ⇄ MID LEVEL ⇄  
 MID WIDTH ⇄ HIGH LEVEL ⇄  
 HIGH FREQ. ⇄ (back to the beginning)

- **(LOW, MID, HIGH) LEVEL:**  
Adjust the enhancement level.
- **(LOW, HIGH) FREQ:**  
Select the center frequency to adjust.
- **(LOW, MID) WIDTH :**  
Select the band width level.

**4** Adjust the selected sound elements while the indication on step 3 is shown.



Indication	Preset values		
	LOW	MID	HIGH
LEVEL	-06 (min.) to +06 (max.)	-06 (min.) to +06 (max.)	-06 (min.) to +06 (max.)
FREQ	60Hz 80Hz 100Hz 120Hz	—	8kHz 10kHz 12kHz 15kHz
WIDTH	1 (min.) to 4 (max.)	1 (min.) to 2 (max.)	—

**5** Repeat steps 3 and 4 to set (or adjust) the other sound elements.

**6** Select one of the user sound modes (USER 1, USER 2, USER 3).

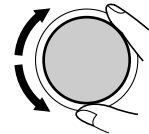
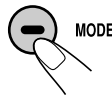

**7** Store the adjustments.

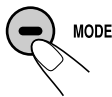

"MEMORY" appears for a while.

# General settings — PSM

## Basic procedure

You can change PSM (Preferred Setting Mode) items (except “SID”) listed in the table that follows.



**2** Select a PSM item.

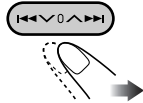

**3** Adjust the PSM item selected.

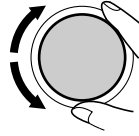

**4** Repeat steps **2** and **3** to adjust the other PSM items if necessary.

**5** Finish the procedure.



Indications	Selectable settings, [reference page]
<b>DEMO MODE</b> Display demonstration	<b>DEMO ON</b> : [Initial]; Display demonstration will be activated automatically if no operation is done for about 20 seconds, [8]. <b>DEMO OFF</b> : Cancels.
<b>CLOCK HOUR</b> Hour adjustment	1 – 12, [8] [Initial: 1 (1:00)]
<b>CLOCK MIN</b> Minute adjustment	00 – 59, [8] [Initial: 00 (1:00)]
<b>CLOCK DISP</b> Clock display	<b>CLOCK ON</b> : Clock time is shown on the display at all times even when the unit is turned off. <b>CLOCK OFF</b> : [Initial]; Clock time is shown when the unit is turned on. If the unit is turned off, pressing DISP will show the clock time for about 5 seconds.

**LEVELMETER**  
Audio level meter

You can select one of the four different level meter patterns or a demonstration of all the patterns.

**LEVEL ALL** [Initial] ⇄ **LEVEL 1** ⇄ **LEVEL 2** ⇄ **LEVEL 3** ⇄ **LEVEL 4** ⇄ **LEVEL OFF** (canceled) ⇄ (back to the beginning)

**LEVEL ALL** : Demonstrates all the level meter patterns, each for about 20 seconds.

**LEVEL 1**

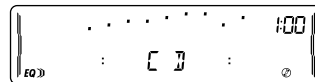

**LEVEL 2**

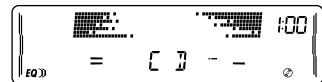

**LEVEL 3**

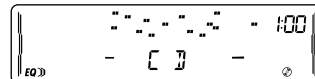

**LEVEL 4**

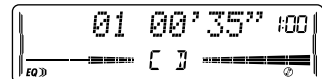

Indications	Selectable settings, [reference page]
<b>CLK ADJ</b> *1 Clock adjustment	<b>AUTO</b> : [Initial]; The built-in clock is automatically adjusted using the clock data provided via the satellite radio channel. <b>OFF</b> : Cancels.
<b>T-ZONE</b> *1, *2 Time zone	Select your residential area from one of the following time zones for clock adjustment. <b>EASTERN</b> [Initial] ⇄ <b>ATLANTIC</b> ⇄ <b>NEWFOUND</b> (Newfoundland) ⇄ <b>ALASKA</b> ⇄ <b>PACIFIC</b> ⇄ <b>MOUNTAIN</b> ⇄ <b>CENTRAL</b> ⇄ (back to the beginning).
<b>DST</b> *1, *2 Daylight saving time	Activate this if your residential area is subject to DST. <b>ON</b> : [Initial]; Activates daylight savings time. <b>OFF</b> : Cancels.
<b>SID</b> *3 SIRIUS® ID	The 12-digit SIRIUS identification number scrolls on the display 5 seconds after “SID” is selected, [24].
<b>DIMMER</b> Dimmer	<b>AUTO</b> : [Initial]; Dims the display when you turn on the headlights. <b>ON</b> : Activates dimmer. <b>OFF</b> : Cancels
<b>CONTRAST</b> Display contrast	<b>1 – 10</b> : Adjust the display contrast to make the display indications clear and legible. [Initial: 5]
<b>SCROLL</b> *4 Scroll	<b>ONCE</b> : [Initial]; Scrolls the disc information once. <b>AUTO</b> : Repeats scrolling (5-second intervals in between). <b>OFF</b> : Cancels. • Pressing DISP for more than one second can scroll the display regardless of the setting.

\*1 Displayed only when SIRIUS Satellite radio or XM Satellite radio is connected.

\*2 Displayed only when “CLK ADJ” is set to “AUTO.”

\*3 Displayed only when SIRIUS Satellite radio is connected.

\*4 Some characters or symbols will not be shown correctly (and will be blanked) or substituted on the display.

Indications	Selectable settings, [reference page]
<b>EXT INPUT</b> *1 External input	<b>CHANGER</b> : [Initial]; To use a JVC CD changer, [13], an Apple iPod or a JVC D. player, [23], a JVC compatible satellite (SIRIUS/XM) tuner, [24]. <b>EXT INPUT</b> : To use another external component, [23].
<b>AUX ADJUST</b> Auxiliary input level adjustment	<b>AUX ADJ 00 – AUX ADJ 05</b> : Adjust the auxiliary input level accordingly, to avoid the sudden increase of the output level when changing the source from external component connected to the AUX input jack on the control panel. [Initial: AUX ADJ 00]
<b>TAG DISP</b> Tag display	<b>TAG ON</b> : [Initial]; Shows the ID3 tag while playing MP3/WMA tracks, [15]. <b>TAG OFF</b> : Cancels.
<b>AMP GAIN</b> Amplifier gain control	You can change the maximum volume level of this unit. <b>LOW PWR</b> : VOLUME 00 – VOLUME 30 (Select this if the maximum power of the speaker is less than 50 W to avoid damaging the speaker.) <b>HIGH PWR</b> : [Initial]; VOLUME 00 – VOLUME 50
<b>IF FILTER</b> IF filter	<b>AUTO</b> : [Initial]; Increases the tuner selectivity to reduce interference noises between close stations. (Stereo effect may be lost.) <b>WIDE</b> : Subject to the interference noises from adjacent stations, but sound quality will not be degraded and maintains the stereo effect.
<b>AREA</b> Tuner channel interval	<b>AREA US</b> : [Initial]; Select this when using the unit in North or South America except for Middle South America. (FM: 200 kHz; AM: 10 kHz) <b>AREA EU</b> : Select this when using the unit in any other area than North, Middle South, and South America. (FM: 50 kHz—manual tuning, 100 kHz—auto search; AM: 9 kHz) <b>AREA SA</b> : Select this when using the unit in Middle South America. (FM: 100 kHz; AM: 10 kHz)

\*1 Cannot be selected if the source is “CD-CH” or “EXT.”

# External component operations

This unit is ready for operating an Apple iPod® or a JVC D. player from the control panel.

- For details, refer also to the manual supplied with the interface adapter for iPod®—KS-PD100 or D. player—KS-PD500.

## Playing an external component

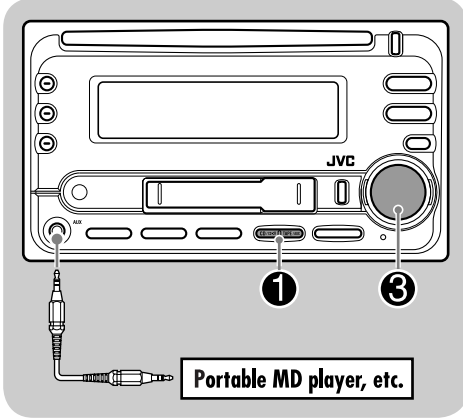

You can connect an external component to....

- CD changer jack on the rear using:
  - **Line Input Adapter**—KS-U57 (not supplied) or **AUX Input Adapter**—KS-U58 (not supplied) for any other components (except iPod or D. player).
  - **Interface adapter for iPod®**—KS-PD100 (not supplied) for controlling iPod.
  - **D. player interface adapter**—KS-PD500 (not supplied) for controlling D. player.
- AUX (auxiliary) input jack on the control panel.

For connection, see Installation/Connection Manual (separate volume).

- 1 For selecting the external component connected to....
  - **AUX input jack**

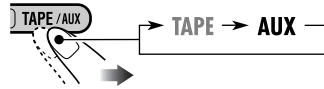

- **CD changer jack on the rear using KS-U57 or KS-U58**  
If "EXT" does not appear, see page 22 and select the external input (EXT INPUT).

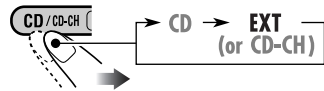

- **CD changer jack on the rear using interface adapter for iPod—KS-PD100 or for D. player—KS-PD500**

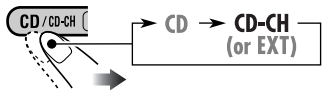

- 2 Turn on the connected component and start playing the source.
- 3 Adjust the volume.

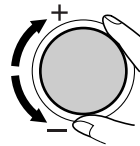

- 4 Adjust the sound as you want.  
(See pages 18 and 19.)

# Satellite radio operations

This unit is Satellite (SAT) Radio Ready—compatible with both SIRIUS Satellite radio and XM Satellite radio.

Before operating your satellite radio:

- For connection, see Installation/Connection Manual (separate volume).
- Refer also to the Instructions supplied with your SIRIUS Satellite radio or XM Satellite radio.
- “SIRIUS” and the SIRIUS dog logo are registered trademarks of SIRIUS Satellite Radio Inc.
- XM and its corresponding logos are registered trademarks of XM Satellite Radio Inc.
- “SAT Radio,” the SAT Radio logo and all related marks are trademarks of SIRIUS Satellite Radio Inc., and XM Satellite Radio, Inc.

## Listening to the satellite radio

Connect either one of the following (separately purchased) to the CD changer jack on the rear of this unit.

- **JVC SIRIUS radio DLP**—Down Link Processor, for listening to the SIRIUS Satellite radio.
- **XMDirect™ Universal Tuner Box using a JVC Smart Digital Adapter**—XMDJVC100 (not supplied), for listening to the XM Satellite radio.

**GCI (Global Control Information) update:**

- If channels are updated after subscription, updating starts automatically. “UPDATING” flashes and no sound can be heard.
- Update takes a few minutes to complete.
- During update, you cannot operate your satellite radio.

## Activate your SIRIUS subscription after connection:

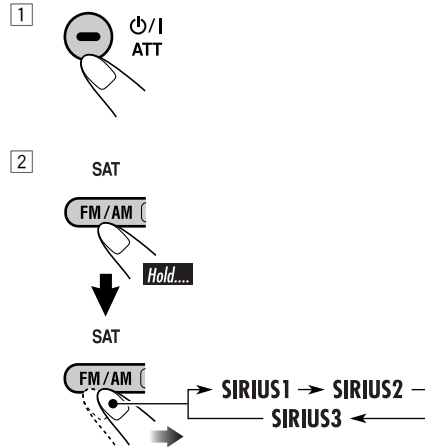

JVC DLP starts updating all the SIRIUS channels.

Once completed, JVC DLP tunes in to the preset channel, CH184.

- 3 **Check your SIRIUS ID, see page 21.**
- 4 **Contact SIRIUS on the internet at <<http://activate.siriusradio.com/>> to activate your subscription, or you can call SIRIUS toll-free at 1-888-539-SIRIUS (7474).** “SUB UPDT PRESS ANY KEY” scrolls on the display once subscription has been completed.

## Activate your XM subscription after connection:

- Only Channel 0, 1, and 247 are available before activation.

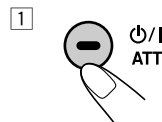



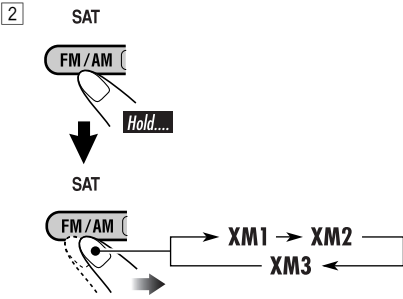

XMDirect™ Universal Tuner Box starts updating all the XM channels. “Channel 1” is tuned in automatically.

**3 Check your XM Satellite radio ID labelled on the casing of the XMDirect™ Universal Tuner Box, or tune in to “Channel 0” (see page 26).**

**4 Contact XM Satellite radio on the internet at <<http://xmradio.com/activation/>> to activate your subscription, or you can call 1-800-XM-RADIO (1-800-967-2346).** Once completed, the unit tunes in to one of the available channels (Channel 4 or higher).

Selecting a particular category (SPORTS, ENTERTAINMENT, etc.) allows you to enjoy only the channels from the selected category.

**3 Select a channel for listening.**

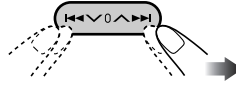

Holding the button changes the channels rapidly.

- When changing the category or channel, invalid and unsubscribed channels are skipped.

## Listening to the XM Satellite radio

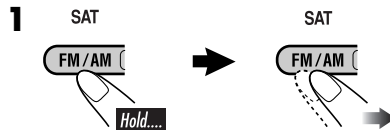

**2 Select a channel for listening.**

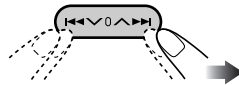

Holding the button changes the channels rapidly.

## Listening to the SIRIUS Satellite radio

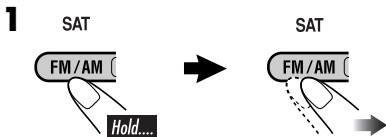

**2 Select a category.**

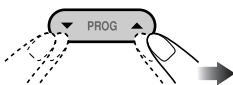

You can tune in to all the channels of every category by selecting “ALL.”

### ■ Category/channel search

You can search for programs by category (Category Search) or channel number (Channel Search).

- **In Category Search,** you can tune in to the channels of the selected category. Category Search begins from the currently selected channel. The selected channel number flashes on the display.
- **In Channel Search,** you can tune in to all the channels (including non-categorised channels).

*To be continued...*

## 1 Select a category (Category Search).

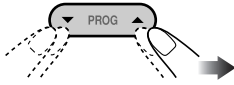

## 2 Select a channel for listening.

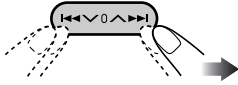

Current channel number



Ex.: When you select "COUNTRY" for Category Search

If no operation is done for about 7 seconds, Category Search is canceled.

In Channel Search, channel name and channel number appear on the display during search.

- While searching, invalid and unsubscribed channels are skipped.

## ■ Checking the XM Satellite radio ID

While selecting "XM1," "XM2," or "XM3," select "Channel 0."

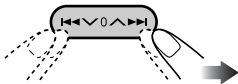

The display alternately shows "RADIO ID" and the 8-digit (alphanumeric) ID number.

To cancel the ID number display, select any channel other than "Channel 0."

## Storing channels in memory

You can preset six channels for each band.

Ex.: Storing a channel into preset number 4.

### 1 Tune in to a channel you want.

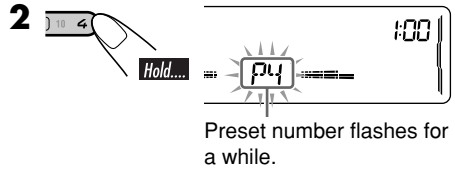

## Listening to a preset channel

### 1 Select either SIRIUS Satellite radio or XM Satellite radio.

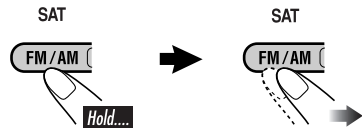

### 2 Select the preset channel (1 – 6) you want.

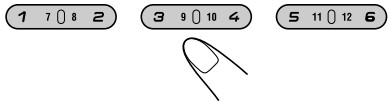

## To change the display information while listening to a channel

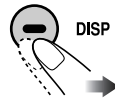

Category name → Channel name → Artist name  
 → Composer name\* → Song/program name/title  
 → (back to the beginning)

\* Only for SIRIUS Satellite radio.

## Handling discs

### Moisture condensation

Moisture may condense on the lens inside the CD player in the following cases:

- After starting the heater in the car.
- If it becomes very humid inside the car.

Should this occur, the CD player may malfunction. In this case, eject the disc and leave the unit turned on for a few hours until the moisture evaporates.

### How to handle discs

When removing a disc from its case, press down the center holder of the case and lift the disc out, holding it by the edges.

Center holder



- Always hold the disc by the edges. Do not touch its recording surface.

When storing a disc into its case, gently insert the disc around the center holder (with the printed surface facing up).

- Make sure to store discs into the cases after use.

### To keep discs clean

A dirty disc may not play correctly.

If a disc does become dirty, wipe it with a soft cloth in a straight line from center to edge.



- Do not use any solvent (for example, conventional record cleaner, spray, thinner, benzene, etc.) to clean discs.

### To play new discs

New discs may have some rough spots around the inner and outer edges. If such a disc is used, this unit may reject the disc.

To remove these rough spots, rub the edges with a pencil or ball-point pen, etc.



Do not use the following discs:

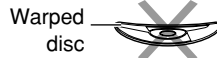

## Handling cassettes

### To clean the head

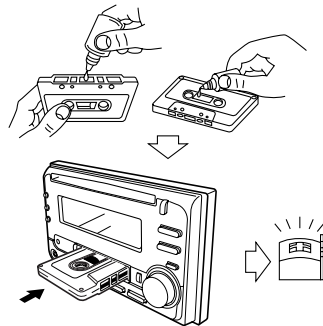

- Clean the heads after every 10 hours of use using a wet-type head cleaning tape (available at an audio store).

When the head becomes dirty, you may realize the following symptoms:

- Sound quality is reduced.
  - Sound level decreases.
  - Sound drops out.
- Do not touch the highly-polished head with any metallic or magnetic tools.

### To keep the tape clean

- Always store the cassettes in their storage cases after use.
- Do not store cassettes in the following places:
  - Subject to direct sunlight
  - With high humidity
  - At extremely hot temperatures

# More about this unit

## Basic operations

### Turning on the power

- By pressing the source buttons on the unit, you can also turn on the power. If the source is ready, playback also starts.

### Turning off the power

- If you turn off the ignition key without turning off this unit, the unit will automatically turn on when you turn on the ignition key next time. If the last selected source is ready for playback (ex. a disc or a tape is in the unit), playback starts automatically.
- If you turn off the power while listening to a disc, disc play will start from where playback has been stopped previously, next time you turn on the power.

### Selecting the sources

- When no disc or cassette is loaded in the unit, "CD" or "TAPE" cannot be selected.
- "SIRIUS," "XM," or "CD-CH" cannot be selected when the target component is not connected.

## Tuner operations

### Storing stations in memory

- During SSM search...
  - All previously stored stations are erased and stations are stored newly.
  - Received stations are preset in No. 1 (lowest frequency) to No. 6 (highest frequency).
  - When SSM is over, the station stored in No. 1 will be automatically tuned in.
- When storing a station manually, the previously preset station is erased when a new station is stored in the same preset number.

## Disc operations

### Caution for DualDisc playback

- The Non-DVD side of a "DualDisc" does not comply with the "Compact Disc Digital Audio" standard. Therefore, the use of Non-DVD side of a DualDisc on this product may not be recommended.

### General

- MP3 and WMA (Windows Media® Audio) "tracks" (words "file" and "track" are used interchangeably) are recorded in "folders."
- This unit has been designed to reproduce CDs/CD Texts, and CD-Rs (Recordable)/CD-RWs (Rewritable) in audio CD (CD-DA), MP3 and WMA format.
- When a disc has been loaded, selecting "CD" for the playback source starts disc play.

### Inserting a disc

- When a disc is inserted upside down, the disc automatically ejects and the unit starts playing the last selected source.
- Do not insert 8 cm (3-3/16") discs (single CD) and unusual shape discs (heart, flower, etc.) into the loading slot.

### Playing a disc

- While fast-forwarding or reversing on an MP3 or WMA disc, you can only hear intermittent sounds.

## **Playing a CD-R or CD-RW**

- Use only “finalized” CD-Rs or CD-RWs.
- This unit can play back only files of the same type which are first detected if a disc includes both audio CD (CD-DA) files and MP3/WMA files.
- This unit can play back multi-session discs; however, unclosed sessions will be skipped while playing.
- Some CD-Rs or CD-RWs may not play back on this unit because of their disc characteristics, or for the following reasons:
  - Discs are dirty or scratched.
  - Moisture condensation occurs on the lens inside the unit.
  - The pickup lens inside the unit is dirty.
  - CD-R/CD-RW on which the files are written with “Packet Write” method.
  - There are improper recording conditions (missing data, etc.) or media conditions (stained, scratched, warped, etc.).
- CD-RWs may require a longer readout time since the reflectance of CD-RWs is lower than that of regular CDs.
- Do not use the following CD-Rs or CD-RWs:
  - Discs with stickers, labels, or protective seal stuck to the surface.
  - Discs on which labels can be directly printed by an ink jet printer.
 Using these discs under high temperatures or high humidity may cause malfunctions or damage to the unit.

## **Playing an MP3/WMA disc**

- This unit can play back MP3/WMA files with the extension code <.mp3> or <.wma> (regardless of the letter case—upper/lower).
- This unit can show the names of albums, artists (performer), and ID3 Tag (Version 1.0, 1.1, 2.2, 2.3, or 2.4) for MP3 files and for WMA files.
- This unit can display only one-byte characters. No other characters can be correctly displayed (see page 11).

- This unit can play back MP3/WMA files meeting the conditions below:
  - Bit rate: 8 kbps — 320 kbps
  - Sampling frequency:
    - 48 kHz, 44.1 kHz, 32 kHz (for MPEG-1)
    - 24 kHz, 22.05 kHz, 16 kHz (for MPEG-2)
    - 48 kHz, 44.1 kHz, 32 kHz (for WMA)
  - Disc format: ISO 9660 Level 1/ Level 2, Romeo, Joliet, Windows long file name
- The maximum number of characters for file/folder names vary among the disc format used (includes 4 extension characters—<.mp3> or <.wma>).
  - ISO 9660 Level 1: up to 12 characters
  - ISO 9660 Level 2: up to 31 characters
  - Romeo\*: up to 128 (72) characters
  - Joliet\*: up to 64 (36) characters
  - Windows long file name\*: up to 128 (72) characters

\* *The parenthetic figure is the maximum number of characters for file/folder names in case the total number of files and folders is 313 or more.*
- This unit can recognize a total of 512 files, of 200 folders, and of 8 hierarchies.
- This unit can play back files recorded in VBR (variable bit rate).  
Files recorded in VBR have a discrepancy in elapsed time display, and do not show the actual elapsed time. This difference becomes noticeable especially after performing the search function.
- This unit cannot play back the following files:
  - MP3 files encoded with MP3i and MP3 PRO format.
  - MP3 files encoded in an unappropriated format.
  - MP3 files encoded with Layer 1/2.
  - WMA files encoded with lossless, professional, and voice format.
  - WMA files which are not based upon Windows Media® Audio.
  - WMA files copy-protected with DRM.
  - Files which have the data such as WAVE, ATRAC3, etc.
- The search function works but search speed is not constant.

*To be continued....*

## Changing the source

- If you change the source, playback also stops (without ejecting the disc).  
Next time you select “CD” or “CD-CH” for the playback source, disc play starts from where it has been stopped previously.

## Ejecting a disc

- If the ejected disc is not removed within 15 seconds, the disc is automatically inserted again into the loading slot to protect it from dust. (Disc will not play this time.)

## Tape operations

### Playing a tape

- While locating a specified tune:
  - If the tape is rewound to its beginning, playback starts from the beginning of that side.
  - If the tape is fast-forwarded to the end, it is reversed and played from the beginning of the other side.
- In the following cases, Multi Music Scan (MMS), Blank Skip, and Repeat Play may not operate correctly:
  - Tapes with tunes having long pianissimo passages (very quiet parts) or non-recorded portions.
  - Tapes with short non-recorded sections.
  - Tapes with high level noise or humming between tunes.
  - The Dolby NR setting does not match. For example, if the tape is recorded with the Dolby C NR.
- Do not use the following tape:
  - Dirty or dusty tapes.
  - Cassette with peeling labels.
  - Loose tape which may become entangled with the mechanism.

- Microsoft and Windows Media are either registered trademarks or trademarks of Microsoft Corporation in the United States and/or other countries.

## Changing the source

- If you change the source, playback also stops (without ejecting the cassette).

## Ignition key-off release

- When you turn off the ignition key with a cassette in the compartment, the unit automatically releases the tape from its head.

## General settings—PSM

- If you change the “TAG DISP” setting from “TAG OFF” to “TAG ON” while playing MP3/WMA file, the tag display will be activated when the next file starts playing.
- If you change the “AMP GAIN” setting from “HIGH PWR” to “LOW PWR” while the volume level is set higher than “VOLUME 30,” the unit automatically changes the volume level to “VOLUME 30.”

## Other main functions

- If you try to assign a title to the 31st station frequency, “NAME FULL” flashes. Delete unwanted titles before assignment.

## Satellite radio operations

- You can also connect the JVC SIRIUS radio PnP (Plug and Play), using the JVC SIRIUS radio adapter, KS-U100K (not supplied) to the CD changer jack on the rear.  
By turning on the power of the unit, you can turn on/off the JVC PnP. However, you cannot control it from this unit.
- To know more about SIRIUS Satellite radio or to sign up, visit <<http://www.sirius.com>>.
- For the latest channel listings and programming information, or to sign up for XM Satellite radio, visit <<http://www.xmradio.com>>.

# Troubleshooting

What appears to be trouble is not always serious. Check the following points before calling a service center.

	Symptoms	Remedies/Causes
<b>General</b>	• Sound cannot be heard from the speakers.	• Adjust the volume to the optimum level. • Check the cords and connections.
	• The unit does not work at all.	Reset the unit (see page 2).
<b>FM/AM</b>	• SSM automatic presetting does not work.	Store stations manually.
	• Static noise while listening to the radio.	Connect the antenna firmly.
<b>Disc playback</b>	• Disc cannot be played back.	Insert the disc correctly.
	• CD-R/CD-RW cannot be played back.	• Insert a finalized CD-R/CD-RW. • Finalize the CD-R/CD-RW with the component which you used for recording.
	• Tracks on the CD-R/CD-RW cannot be skipped.	
	• Disc can be neither played back nor ejected.	• Unlock the disc (see page 15). • Eject the disc forcibly (see page 2).
	• Disc sound is sometimes interrupted.	• Stop playback while driving on rough roads. • Use an unscratched disc. • Check the cords and connections.
	• “NO DISC” appears on the display.	Insert a correct disc into the loading slot.
<b>MP3/WMA playback</b>	• Disc cannot be played back.	• Use a disc with MP3/WMA tracks recorded in the format compliant with ISO 9660 Level 1, Level 2, Romeo, or Joliet. • Add the extension code <.mp3> or <.wma> to the file names.
	• Noise is generated.	Skip to another track or change the disc. (Do not add the extension code <.mp3> or <.wma> to non-MP3 or WMA tracks.)
	• A longer readout time is required (“CHECK” keeps flashing on the display).	Do not use too many hierarchies and folders.
	• Tracks do not play back in the order you have intended them to play.	Playback order is determined when the files are recorded.
	• Elapsed playing time is not correct.	This sometimes occurs during play. This is caused by how the tracks are recorded on the disc.
	• “NO FILES” appears on the display.	Insert a disc that contains MP3/WMA tracks.
<b>Tape playback</b>	• A cassette cannot be inserted.	Insert the cassette with the exposed tape facing right.
	• Cassette can be neither played back nor ejected.	Unlock the cassette (see page 17).
	• “NO TAPE” appears on the display.	Insert a cassette correctly.
	• Cassette tapes become hot.	This is not a malfunction.
	• Tape sound is at very low level and sound quality is degraded.	Clean the tape head using a head cleaning tape.

To be continued....

	Symptoms	Remedies/Causes
CD changer	<ul style="list-style-type: none"> <li>• “NO DISC” appears on the display.</li> </ul>	Insert a disc into the magazine.
	<ul style="list-style-type: none"> <li>• “NO MAG” appears on the display.</li> </ul>	Insert the magazine.
	<ul style="list-style-type: none"> <li>• “RESET 8” appears on the display.</li> </ul>	Connect this unit and the CD changer correctly and press the reset button of the CD changer.
	<ul style="list-style-type: none"> <li>• “RESET 1” – “RESET 7” appears on the display.</li> </ul>	Press the reset button of the CD changer.
	<ul style="list-style-type: none"> <li>• The CD changer does not work at all.</li> </ul>	Reset the unit (see page 2).
Satellite radio	<ul style="list-style-type: none"> <li>• “CALL 1-888-539-SIRIUS TO SUBSCRIBE” scrolls on the display while listening to the SIRIUS Satellite radio.</li> </ul>	Starts subscribing SIRIUS Satellite radio (see page 24).
	<ul style="list-style-type: none"> <li>• No sound can be heard. “UPDATING” appears on the display.</li> </ul>	The unit is updating the channel information and it takes a few minutes to complete.
	<ul style="list-style-type: none"> <li>• Either “NO SIGNAL” scrolls or “NO SIGNL” appears on the display.</li> </ul>	Move to an area where signals are stronger.
	<ul style="list-style-type: none"> <li>• Either “NO ANTENNA” scrolls or “ANTENNA” appears on the display.</li> </ul>	Connect the antenna firmly.
	<ul style="list-style-type: none"> <li>• “NO CH” appears on the display for about 5 seconds, then returns to the previous display while listening to the SIRIUS Satellite radio.</li> </ul>	No broadcast on the selected channel. Select another channel or continue listening to the previous channel.
	<ul style="list-style-type: none"> <li>• “NO (information)*” scrolls on the display while listening to the SIRIUS Satellite radio.</li> <li>• “---” appears on the display while listening to the XM Satellite radio.</li> </ul>	No text information for the selected channel.
	<ul style="list-style-type: none"> <li>• “---” appears on the display for about 2 seconds, then returns to the previous channel while listening to the XM Satellite radio.</li> </ul>	Selected channel is no longer available or is unauthorized. Select another channel or continue listening to the previous channel.
	<ul style="list-style-type: none"> <li>• “OFF AIR” appears on the display while listening to the XM Satellite radio.</li> </ul>	Selected channel is not broadcasting at this time. Select another channel or continue listening to the previous channel.
	<ul style="list-style-type: none"> <li>• “LOADING” appears on the display while listening to the XM Satellite radio.</li> </ul>	The unit is loading the channel information and audio. Text information are temporarily unavailable.
	<ul style="list-style-type: none"> <li>• “RESET 8” appears on the display.</li> <li>• Satellite radio does not work at all.</li> </ul>	Reconnect this unit and the satellite radio correctly and press the reset button of this unit.

\* NO CATEGORY, NO ARTIST, NO COMPOSER, and NO SONG/PROGRAM



# Specifications

## AUDIO AMPLIFIER SECTION

Power Output:  
18 W RMS × 4 Channels at 4 Ω  
and ≤ 1% THD+N  
Signal to Noise Ratio:  
80 dBA (reference: 1 W into 4 Ω)



Load Impedance: 4 Ω (4 Ω to 8 Ω allowance)  
Equalizer Control Range:  
Low: ±12 dB (60 Hz, 80 Hz, 100 Hz, 120 Hz)  
Mid: ±12 dB  
High: ±12 dB (8 kHz, 10 kHz, 12 kHz, 15 kHz)  
Frequency Response: 40 Hz to 20 000 Hz  
Line-Out Level/Impedance:  
2.0 V/20 kΩ load (full scale)  
Output Impedance: 1 kΩ  
Other Terminals: CD changer, AUX  
(auxiliary) input jack,  
Steering wheel remote input

## TUNER SECTION

Frequency Range:  
FM: 87.5 MHz to 107.9 MHz  
(with channel interval set to 100 kHz  
or 200 kHz)  
87.5 MHz to 108.0 MHz  
(with channel interval set to 50 kHz)  
AM: 530 kHz to 1 710 kHz  
(with channel interval set to 10 kHz)  
531 kHz to 1 602 kHz  
(with channel interval set to 9 kHz)

### [FM Tuner]

Usable Sensitivity: 11.3 dBf (1.0 μV/75 Ω)  
50 dB Quietening Sensitivity:  
16.3 dBf (1.8 μV/75 Ω)  
Alternate Channel Selectivity (400 kHz): 65 dB  
Frequency Response: 40 Hz to 15 000 Hz  
Stereo Separation: 35 dB  
Capture Ratio: 1.5 dB

### [AM Tuner]

Sensitivity: 20 μV  
Selectivity: 35 dB

## CD PLAYER SECTION

Type: Compact disc player  
Signal Detection System: Non-contact optical  
pickup (semiconductor laser)  
Number of Channels: 2 channels (stereo)  
Frequency Response: 5 Hz to 20 000 Hz  
Dynamic Range: 96 dB  
Signal-to-Noise Ratio: 98 dB  
Wow and Flutter: Less than measurable limit  
MP3 Decoding Format:  
MPEG1/2 Audio Layer 3  
Max. Bit Rate: 320 kbps  
WMA (Windows Media® Audio) Decoding  
Format:  
Max. Bit Rate: 192 kbps

## CASSETTE DECK SECTION

Wow and Flutter: 0.1 % (WRMS)  
Fast-Wind Time: 100 sec. (C-60)  
Frequency Response: 30 Hz to 16 000 Hz  
(Normal tape)  
Signal-to-Noise Ratio: (Normal tape)  
Dolby B NR ON: 65 dB  
Dolby B NR OFF: 56 dB  
Stereo Separation: 40 dB

## GENERAL

Power Requirement:  
Operating Voltage:  
DC 14.4 V (11 V to 16 V allowance)  
Grounding System: Negative ground  
Allowable Operating Temperature:  
0°C to +40°C (32°F to 104°F)  
Dimensions (W × H × D):  
Installation Size (approx.):  
178 mm × 100 mm × 158 mm  
(7-1/16" × 3-15/16" × 6-1/4")  
Set Size (approx.):  
178 mm × 100 mm × 175 mm  
(7-1/16" × 3-15/16" × 6-15/16")  
Mass (approx.):  
2.3 kg (5.1 lbs) (excluding accessories)

*Design and specifications are subject to change without notice.*

If a kit is necessary for your car, consult your telephone directory for the nearest car audio speciality shop.



**Having TROUBLE with operation?  
Please reset your unit  
Refer to page of How to reset your unit  
Still having trouble??**

**USA ONLY**

**Call 1-800-252-5722**

**<http://www.jvc.com>**

**We can help you!**

**JVC**



EN, SP, FR

© 2005 Victor Company of Japan, Limited

1105DTSMDTJEIN

# JVC KW-XC410/KW-XC400

## Installation/Connection Manual

## Manual de instalación/conexión

## Manuel d'installation/raccordement

GET0320-002B  
[J]

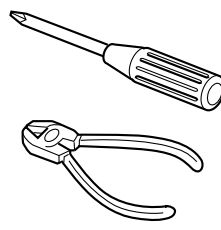

1105DTSMDTJEIN  
EN, SP, FR

© 2005 Victor Company of Japan, Limited

### ENGLISH

This unit is designed to operate on **12 V DC, NEGATIVE ground electrical systems**. If your vehicle does not have this system, a voltage inverter is required, which can be purchased at JVC car audio dealers.

### ESPAÑOL

Esta unidad está diseñada para funcionar con **12 V de CC, con sistemas eléctricos de masa NEGATIVA**. Si su vehículo no posee este sistema, será necesario un inversor de tensión, que puede ser adquirido en los concesionarios de JVC de equipos de audio para automóviles.

### FRANÇAIS

Cet appareil est conçu pour fonctionner sur des sources de courant continu de **12 V à masse NEGATIVE**. Si votre véhicule n'offre pas ce type d'alimentation, il vous faut un convertisseur de tension, que vous pouvez acheter chez un revendeur d'autoradios JVC.

#### Parts list for installation and connection

The following parts are provided for this unit. After checking them, please set them correctly.

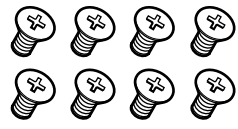

Flat countersunk screws—M5 × 8 mm (M5 × 3/8")  
Tornillos de cabeza avellanada plana—M5 × 8 mm (M5 × 3/8 pulgada)  
Vis plat à tête fraisée—M5 × 8 mm (M5 × 3/8 pouces)



Binding screws—M5 × 8 mm (M5 × 3/8")  
Tornillos de fijación—M5 × 8 mm (M5 × 3/8 pulgada)  
Vis de serrage—M5 × 8 mm (M5 × 3/8 pouces)

#### Lista de piezas para instalación y conexión

Con esta unidad se suministran las siguientes piezas. Después de inspeccionarlas, colóquelas correctamente.

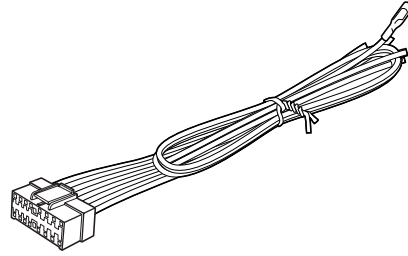

Power cord  
Cordón de alimentación  
Cordon d'alimentation



CR2025

Battery  
Pila  
Pile

#### Liste des pièces pour l'installation et raccordement

Les pièces suivantes sont fournies avec cet appareil. Après vérification, veuillez les placer correctement.

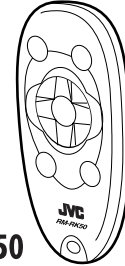

RM-RK50

Remote controller  
Control remoto  
Télécommande

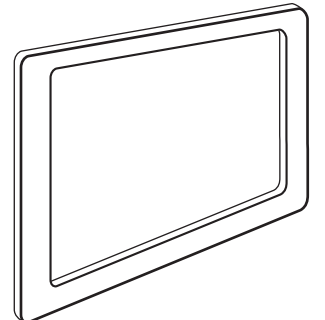

Plate for use with a Nissan car  
Placa para usar con un automóvil Nissan  
Plaque à utiliser avec une voiture Nissan

#### When installing the unit in a Nissan car

#### Cuando instale la unidad en un automóvil Nissan

#### Lors de l'installation de l'appareil dans une voiture Nissan

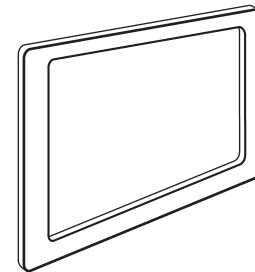
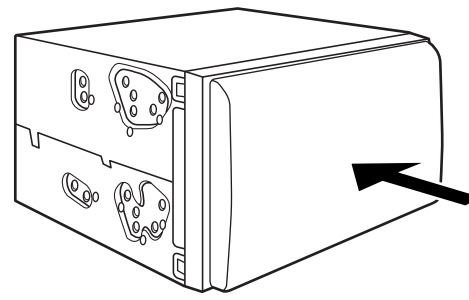
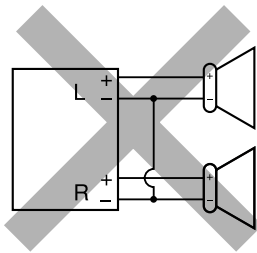

Plate for use with a Nissan car  
Placa para usar con un automóvil Nissan  
Plaque à utiliser avec une voiture Nissan

Fix the supplied plate as illustrated.  
Fije la placa suministrada de la manera indicada en la ilustración.  
Fixez la plaque fournie comme montré sur l'illustration.

#### PRECAUTIONS on power supply and speaker connections:

- **DO NOT connect the speaker leads of the power cord to the car battery; otherwise, the unit will be seriously damaged.**
- BEFORE connecting the speaker leads of the power cord to the speakers, check the speaker wiring in your car.



#### PRECAUCIONES sobre las conexiones de la fuente de alimentación y de los altavoces:

- **NO conecte los conductores de altavoz del cable de alimentación a la batería de automóvil, pues podrían producirse graves daños en la unidad.**
- ANTES de conectar a los altavoces los conductores de altavoz del cable de alimentación, verifique el conexionado de altavoz de su automóvil.

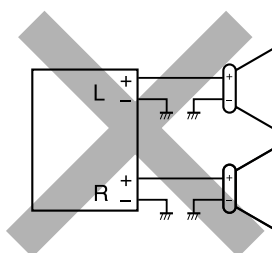

#### PRECAUTIONS sur l'alimentation et la connexion des enceintes:

- **NE CONNECTEZ PAS les fils d'enceintes du cordon d'alimentation à la batterie; sinon, l'appareil serait sérieusement endommagé.**
- AVANT de connecter les fils d'enceintes du cordon d'alimentation aux enceintes, vérifiez le câblage des enceintes de votre voiture.

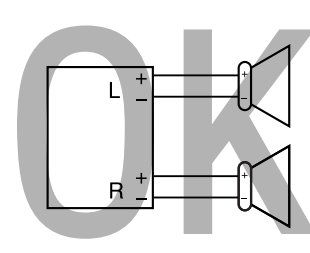

### TROUBLESHOOTING

- **The fuse blows.**  
\* Are the red and black leads connected correctly?
- **Power cannot be turned on.**  
\* Is the yellow lead connected?
- **No sound from the speakers.**  
\* Is the speaker output lead short-circuited?
- **Sound is distorted.**  
\* Is the speaker output lead grounded?  
\* Are the "-" terminals of L and R speakers grounded in common?
- **Noise interfere with sounds.**  
\* Is the rear ground terminal connected to the car's chassis using shorter and thicker cords?
- **This unit becomes hot.**  
\* Is the speaker output lead grounded?  
\* Are the "-" terminals of L and R speakers grounded in common?
- **This unit does not work at all.**  
\* Have you reset your unit?

### LOCALIZACION DE AVERIAS

- **El fusible se quema.**  
\* ¿Están los conductores rojo y negro correctamente conectados?
- **No es posible conectar la alimentación.**  
\* ¿Está el cable amarillo conectado?
- **No sale sonido de los altavoces.**  
\* ¿Está el cable de salida del altavoz cortocircuitado?
- **El sonido presenta distorsión.**  
\* ¿Está el cable de salida del altavoz conectado a masa?  
\* ¿Están los terminales "-" de los altavoces L y R conectados a una masa común?
- **Perturbación de ruido.**  
\* ¿El terminal de tierra trasero está conectado al chasis del automóvil utilizando los cordones más corto y más grueso?
- **La unidad se calienta.**  
\* ¿Está el cable de salida del altavoz conectado a masa?  
\* ¿Están los terminales "-" de los altavoces L y R conectados a una masa común?
- **Este receptor no funciona en absoluto.**  
\* ¿Reinicializó el receptor?

### EN CAS DE DIFFICULTES

- **Le fusible saute.**  
\* Les fils rouge et noir sont-ils raccordés correctement?
- **L'appareil ne peut pas être mise sous tension.**  
\* Le fil jaune est-elle raccordée?
- **Pas de son des enceintes.**  
\* Le fil de sortie d'enceinte est-il court-circuité?
- **Le son est déformé.**  
\* Le fil de sortie d'enceinte est-il à la masse?  
\* Les bornes "-" des enceintes gauche et droit sont-elles mises ensemble à la masse?
- **Interférence avec les sons.**  
\* La prise arrière de mise à la terre est-elle connectée au châssis de la voiture avec un cordon court et épais?
- **L'appareil devient chaud.**  
\* Le fil de sortie d'enceinte est-il à la masse?  
\* Les bornes "-" des enceintes gauche et droit sont-elles mises ensemble à la masse?
- **Cet appareil ne fonctionne pas du tout.**  
\* Avez-vous réinitialisé votre appareil?

## INSTALLATION (IN-DASH MOUNTING)

The following illustration shows a typical installation. However, you should make adjustments corresponding to your specific car. In this case consult the manual included with the installation kit (option). In some case, depending of the type and the model of your car, it is not possible to install the unit into the center console. If you have any questions or require information regarding installation kits, consult your JVC car audio dealers or a company supplying kits.

- If you are not sure how to install this unit correctly, have it installed by a qualified technician.

### Before installing the unit

- When mounting the unit, be sure to use the screws provided, as instructed. If other screws are used, there is a possibility that parts could become loose or damaged.
- When tightening screws or bolts be careful not to pinch any connection cord.

- 1 Remove the audio system originally installed together with the mounting brackets.  
**Note:** Be sure to keep all the screws and parts removed from your car for future use.
- 2 Attach the mounting brackets (removed from the car), to this unit (see below).
- 3 Connect the wires (see diagram **A**).
- 4 Fix this unit to the car using the screws removed in step 1.  
• See "Caution" below.

The following example shown is for installation in a Toyota car. For more details, consult your JVC car audio dealer.

## INSTALACION (MONTAJE EN EL TABLERO DE INSTRUMENTOS)

La siguiente ilustración muestra una instalación típica. Sin embargo, deberá realizar los ajustes que correspondan a su automóvil. En tal caso, consulte el manual entregado con el kit de instalación (opción).

En algunos casos, y dependiendo del tipo y modelo de su automóvil, es posible que no se pueda instalar esta unidad en la consola central. Si tiene alguna pregunta o necesita información acerca de las herramientas para instalación, consulte con su concesionario de JVC de equipos de audio para automóviles o a una compañía que suministra tales herramientas.

- Si usted no está seguro de cómo instalar correctamente la unidad, hágala instalar por un técnico cualificado.

### Antes de instalar la unidad

- Al instalar la unidad, asegúrese de usar los tornillos suministrados, tal como se especifica. Si utiliza otros tornillos, puede suceder que las piezas se aflojen o dañen.
- Al apretar los tornillos o los pernos, tenga cuidado de no pillar ningún cable de conexión.

- 1 Desmonte el sistema de audio instalado originalmente junto con los soportes de montaje.  
**Nota:** Asegúrese de guardar todos los tornillos y piezas quitados de su vehículo para poderlos usar en el futuro.
- 2 Fije los soportes de montaje (removidos del vehículo) a esta unidad (véase abajo).
- 3 Conecte los cables (véase el diagrama **A**).
- 4 Fije esta unidad al automóvil usando los tornillos quitados en el paso 1.  
• Véase "Precaución" más abajo.

El ejemplo siguiente muestra la instalación de un automóvil Toyota. Para mayor información, consulte con su concesionario car audio JVC.

## INSTALLATION (MONTAGE DANS LE TABLEAU DE BORD)

L'illustration suivante est un exemple d'installation typique. Cependant, vous devez réaliser les ajustements correspondant à votre propre voiture. Dans ce cas, consultez le manuel fourni avec le kit d'installation (optionnel). Dans certains cas, en fonction du type de modèle de votre voiture, il n'est pas possible d'installer l'appareil dans la console centrale. Si vous avez des questions ou avez besoin d'information sur des kits d'installation, consultez votre revendeur d'autoradios JVC ou une compagnie d'approvisionnement.

- Si l'on n'est pas sûr de pouvoir installer correctement cet appareil, le faire installer par un technicien qualifié.

### Avant d'installer l'appareil

- Lors du montage de l'appareil, assurez-vous d'utiliser les vis fournies de la façon indiquée. Si vous utilisez d'autres vis, certaines pièces peuvent devenir lâches ou être endommagées.
- Lors du serrage de vis ou de boulons, faites attention de ne pas pincer de cordon de connexion.

- 1 Retirez le système audio d'origine installé en même temps que les supports de montage.  
**Remarque:** Assurez-vous de conserver toutes les vis et pièces détachées de votre voiture pour une utilisation dans le futur.
- 2 Fixez les supports de montage (retirés de la voiture) à cet appareil (voir ci-dessous).
- 3 Connectez le fils (voir le diagramme **A**).
- 4 Fixez cet appareil à la voiture en utilisant les vis retirées à l'étape 1.  
• Référez-vous aux "Précautions" ci-dessous.

Les exemples montrés ci-dessous correspondent à une installation dans une voiture Toyota. Pour plus de détails, consultez votre revendeur autoradio JVC.

Securely connect the ground wire to the metal body of the car using the screw originally fixed to the metal body of the car. Connecte fermement le câble de terre à la carrosserie métallique du véhicule en utilisant la vis fixée à l'origine au châssis métallique de la voiture.

Mounting bracket removed from the car  
Soporte de montaje removido del automóvil  
Support de montage retiré de la voiture

Screws supplied for this unit  
Tornillos suministrados para esta unidad  
Vis fournis avec cet appareil

Mounting bracket removed from the car  
Soporte de montaje removido del automóvil  
Support de montage retiré de la voiture

Screws supplied for this unit  
Tornillos suministrados para esta unidad  
Vis fournis avec cet appareil

Screw removed from the car in step 1  
Tornillo removido del automóvil en el paso 1  
Vis retiré de la voiture à l'étape 1

### Screws supplied for this unit: Tornillos suministrados para esta unidad: Vis fournis avec cet appareil:

Select the proper screw type, fitting to your car.  
Seleccione el tipo de rosca correcto, adecuado a su automóvil.  
Choisissez le type de vis correct, en fonction de votre voiture.

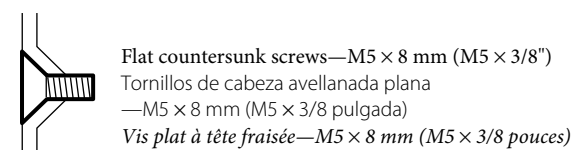
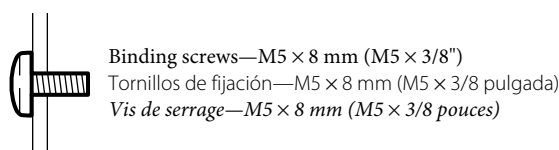

### Caution:

To install the mounting brackets to the unit, use only the supplied screws—M5 × 8 mm (M5 × 3/8"). If you use any screw longer than 8 mm (3/8"), the unit can be damaged.

### Precaución:

Para instalar los soportes de montaje en la unidad, utilice solamente los tornillos suministrados—M5 × 8 mm (M5 × 3/8 pulgada). El uso de cualquier tornillo de más de 8 mm (3/8 pulgada), de largo puede producir daños a la unidad.

### Précautions:

Pour installer les supports de montage sur l'appareil, utilisez uniquement les vis fournies—M5 × 8 mm (M5 × 3/8 pouces). Si vous utilisez une vis plus longue que 8 mm (3/8 pouces), l'appareil peut être endommagé.

If there is an interfering tab on the mounting bracket, bent it flat.  
Si hay alguna lengüeta que interfiere con el soporte de montaje, dóblela hasta que quede plana.  
S'il y a une languette gênante sur le support de montage, aplatissez-la.

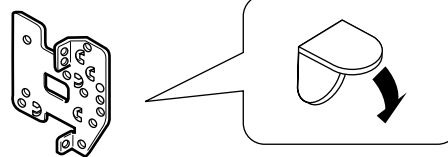

Install the unit at an angle of less than 30°.  
Instale la unidad a un ángulo de menos de 30°.  
Installez l'appareil avec un angle de moins de 30°.

Less than 30°  
Menos de 30°.  
Moins de 30°.

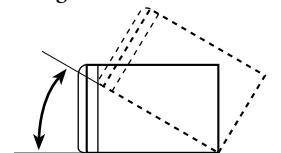

## ELECTRICAL CONNECTIONS

To prevent short circuits, we recommend that you disconnect the battery's negative terminal and make all electrical connections before installing the unit.

- Be sure to ground this unit to the car's chassis again after installation.

### Notes:

- Replace the fuse with one of the specified rating. If the fuse blows frequently, consult your JVC car audio dealer.
- If noise is a problem...  
This unit incorporates a noise filter in the power circuit. However, with some vehicles, clicking or other unwanted noise may occur. If this happens, connect the unit's rear ground terminal to the car's chassis using shorter and thicker cords, such as copper braiding or gauge wire. If noise still persists, consult your JVC car audio dealer.
- It is recommended to connect to the speakers with maximum power of more than 50 W (both at the rear and at the front, with an impedance of 4 Ω to 8 Ω). If the maximum power is less than 50 W, change "AMP GAIN" setting to prevent the speakers from being damaged (see page 22 of the INSTRUCTIONS).
- The heat sink becomes very hot after use. Be careful not to touch it when removing this unit.

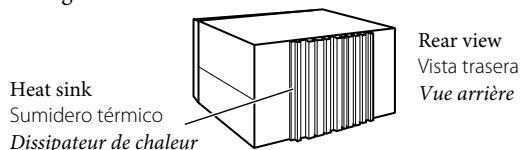

## CONEXIONES ELECTRICAS

Para evitar cortocircuitos, recomendamos que desconecte el terminal negativo de la batería y que efectúe todas las conexiones eléctricas antes de instalar la unidad.

- Asegúrese de volver a conectar a masa esta unidad al chasis del automóvil después de la instalación.

### Notas:

- Reemplace el fusible por uno con la corriente especificada. Si el fusible se quemase frecuentemente consulte con su concesionario de JVC de equipos de audio para automóviles.
- Si el ruido es un problema...  
Esta unidad incorpora un filtro de ruido en el circuito de alimentación. Sin embargo, en algunos vehículos, pueden producirse chasquidos u otros ruidos indeseables. En tal caso, conecte el terminal de tierra trasero de la unidad al chasis del automóvil utilizando cables más cortos y gruesos, como por ejemplo, cables de cobre estañado o conductor. Si los ruidos persisten, consulte con su concesionario car audio JVC.
- Se recomienda conectar los altavoces con una potencia máxima de más de 50 W (tanto atrás como adelante, con una impedancia de 4 Ω a 8 Ω). Si la potencia máxima es de menos de 50 W, cambie "AMP GAIN" para evitar daños en los altavoces (consulte la página 22 del MANUAL DE INSTRUCCIONES).
- El sumidero térmico estará muy caliente después del uso. Asegúrese de no tocarlo al desmontar esta unidad.

## RACCORDEMENTS ELECTRIQUES

Pour éviter tout court-circuit, nous vous recommandons de débrancher la borne négative de la batterie et d'effectuer tous les raccordements électriques avant d'installer l'appareil.

- Assurez-vous de raccorder de nouveau la mise à la masse de cet appareil au châssis de la voiture après l'installation.

### Remarques:

- Remplacer le fusible par un de la valeur précisée. Si le fusible saute souvent, consultez votre revendeur d'autoradios JVC.
- Si du bruit se produit...  
Cet appareil intègre un filtre anti-bruit dans le circuit d'alimentation. Cependant, avec certains véhicules, un clic ou un autre bruit gênant peut se produire. Si cela se produit, connectez la prise de mise à la masse située à l'arrière de l'appareil au châssis de la voiture en utilisant un cordon court et épais, tel qu'une tresse en cuivre ou un fil de calibre. Si le bruit persiste, consultez votre revendeur autoradio JVC.
- Il est recommandé de connecter des enceintes avec une puissance de plus de 50 W (les enceintes arrière et les enceintes avant, avec une impédance comprise entre 4 Ω et 8 Ω). Si la puissance maximum est inférieure à 50 W, changez "AMP GAIN" pour éviter d'endommager vos enceintes (voir page 22 du MANUAL D'INSTRUCTIONS).
- Le dissipateur de chaleur devient très chaud après usage. Faire attention de ne pas le toucher en retirant cet appareil.

**A Typical connections / Conexiones típicas / Raccordements typiques**

**Before connecting:** Check the wiring in the vehicle carefully. Incorrect connection may cause serious damage to this unit. The leads of the power cord and those of the connector from the car body may be different in color.

- 1 Connect the colored leads of the power cord in the order specified in the illustration below.
- 2 Connect the antenna cord.
- 3 Finally connect the wiring harness to the unit.

**Antes de la conexión:** Verifique atentamente el conexionado del vehículo. Una conexión incorrecta podría producir daños graves en la unidad.

Los cordones del cable de alimentación y los del conector procedentes de la carrocería del automóvil podrían ser de diferentes en color.

- 1 Conecte los conductores de color del cable de alimentación en el orden especificado en la ilustración de abajo.
- 2 Conecte el cable de antena.
- 3 Por último, conecte el cable de alimentación a la unidad.

**Avant de commencer la connexion:** Vérifiez attentivement le câblage du véhicule. Une connexion incorrecte peut endommager sérieusement l'appareil.

Le fil du cordon d'alimentation et ceux des connecteurs du châssis de la voiture peuvent être différents en couleur.

- 1 Connectez les fils colorés du cordon d'alimentation dans l'ordre spécifié sur l'illustration ci-dessous.
- 2 Connectez le cordon d'antenne.
- 3 Finalement, connectez le faisceau de fils à l'appareil.

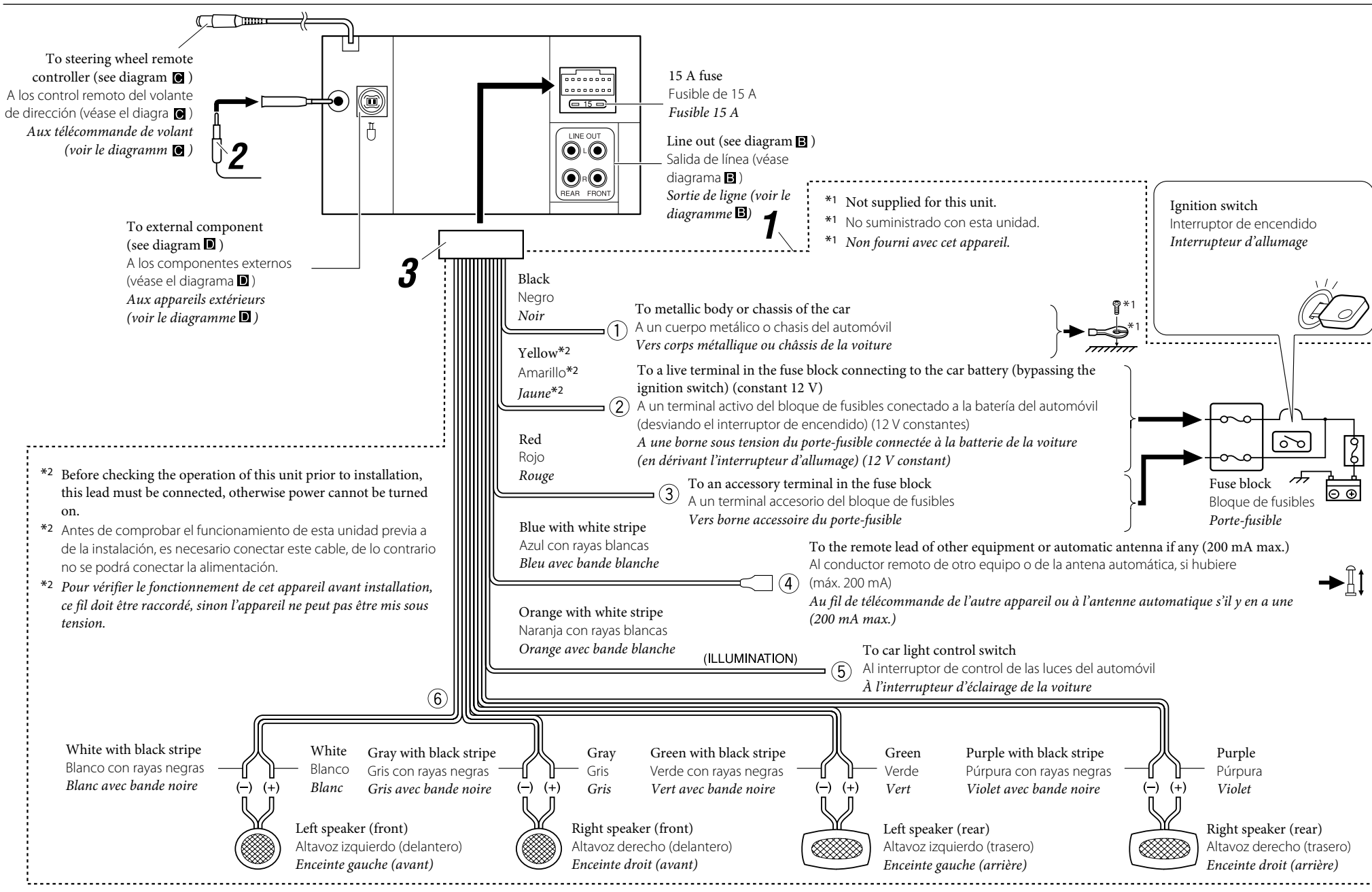

**B Connecting the external amplifier / Conexión al amplificador externo / Connexion d'un amplificateur extérieur**

You can connect amplifiers to upgrade your car stereo system.

- Connect the remote lead (blue with white stripe) to the remote lead of the other equipment so that it can be controlled through this unit.
- **Disconnect the speakers from this unit, connect them to the amplifier. Leave the speaker leads of this unit unused.**

Usted podrá conectar amplificadores para mejorar el sistema estereo de su automóvil.

- Conecte el conductor remoto (azul con rayas blancas) al conductor remoto del otro equipo para poderlo controlar a través de esta unidad.
- **Desconecte los altavoces de esta unidad y conéctelos al amplificador. Los cables de los altavoces de esta unidad quedan sin usar.**

Vous pouvez connecter des amplificateurs pour améliorer votre système autoradio.

- Connectez le fil de commande à distance (bleu avec bande blanche) au fil de commande à distance de l'autre appareil de façon qu'il puisse être commandé via cet appareil.
- **Déconnectez les enceintes de cet appareil et connectez-les à l'amplificateur. Laissez les fils d'enceintes de cet appareil inutilisés.**

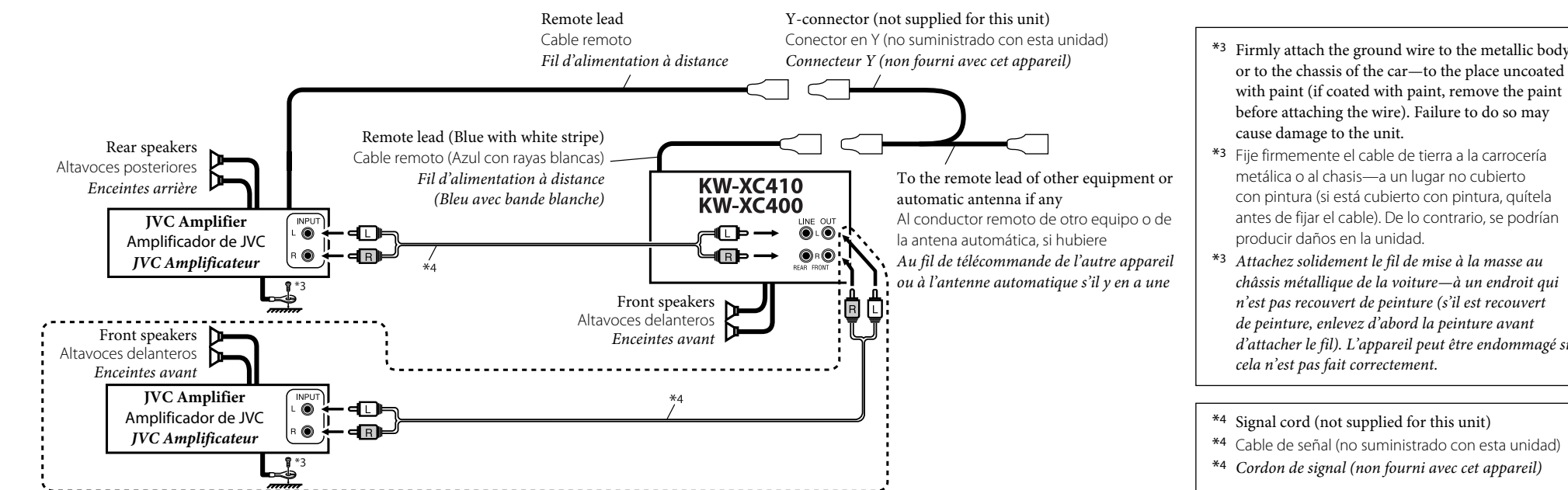

**C Connecting to the steering wheel remote controller / Conexión al control remoto del volante de dirección / Connexion de la télécommande de volant**

If your car is equipped with the steering wheel remote controller, you can operate this unit using the controller. To do it, a JVC's OE remote adapter (not supplied) which matches with your car is required. Consult your JVC car audio dealer for details.

Si su vehículo está equipado con control remoto en el volante de dirección, podrá hacer funcionar este receptor utilizando dicho control. Para ello, se requiere un adaptador para control remoto OE de JVC (no suministrado) que corresponda con su vehículo. Para mayor información, consulte con su concesionario car audio de JVC.

Si votre voiture est munie d'une télécommande de volant, vous pouvez commander cet autoradio en utilisant la télécommande. Pour le faire, un adaptateur pour télécommande au volant JVC (non fourni) correspondant à votre voiture est nécessaire. Consultez votre revendeur d'autoradio JVC pour les détails.

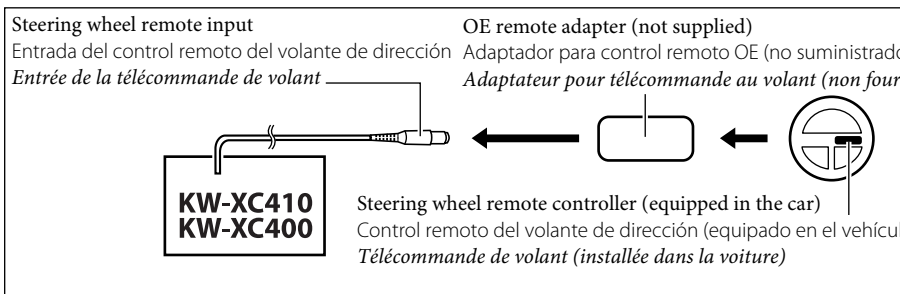

## D Connecting other external components / Conexión de otros componentes externos / Connexion d'un autre appareil extérieur

• Set "EXT INPUT" to "CHANGER" (See page 22 of the INSTRUCTIONS.) / Ajuste "EXT INPUT" a "CHANGER" (Consulte la página 22 del MANUAL DE INSTRUCCIONES.) / Réglez "EXT INPUT" sur "CHANGER" (Voir la page 22 du MANUEL D'INSTRUCTIONS.)

### JVC CD changer, SIRIUS Satellite radio, XM Satellite radio, Apple iPod®, or JVC D. player / Cambiador de CD de JVC, radio satelital SIRIUS, radio satelital XM, iPod® de Apple o reproductor JVC D. / Changeur de CD JVC, radio satellite SIRIUS, radio satellite XM, iPod® Apple ou lecteur D. JVC

You can connect these components in series as illustrated below.

- For listening to the SIRIUS Satellite radio, connect a JVC DLP —Down Link Processor (separately purchased) to this unit.
- The iPod\*5 or D. player can be connected using an interface adapter (not supplied)—KS-PD100 (for iPod) or KS-PD500 (for D. player).

Estos componentes se pueden conectar en serie, tal como se muestra en la ilustración de abajo.

- Para escuchar la radio satelital SIRIUS, conecte un DLP (Down Link Processor) de JVC (adquirido por separado) al receptor.
- Puede conectar el iPod\*5 o el reproductor D. usando un adaptador de interfaz (no suministrado)—KS-PD100 (para iPod) o KS-PD500 (para el reproductor D.).

Vous pouvez connecter ces appareils en série comme montrée sur l'illustration.

- Pour écouter la radio satellite SIRIUS, connectez un processeur DLP JVC —Processeur de signaux satellite-terre (vendu séparément) à cet appareil.
- Le iPod\*5 ou le lecteur D. peut être connecté en utilisant un adaptateur d'interface (non fourni)—KS-PD100 (pour iPod) ou KS-PD500 (pour le lecteur D.).

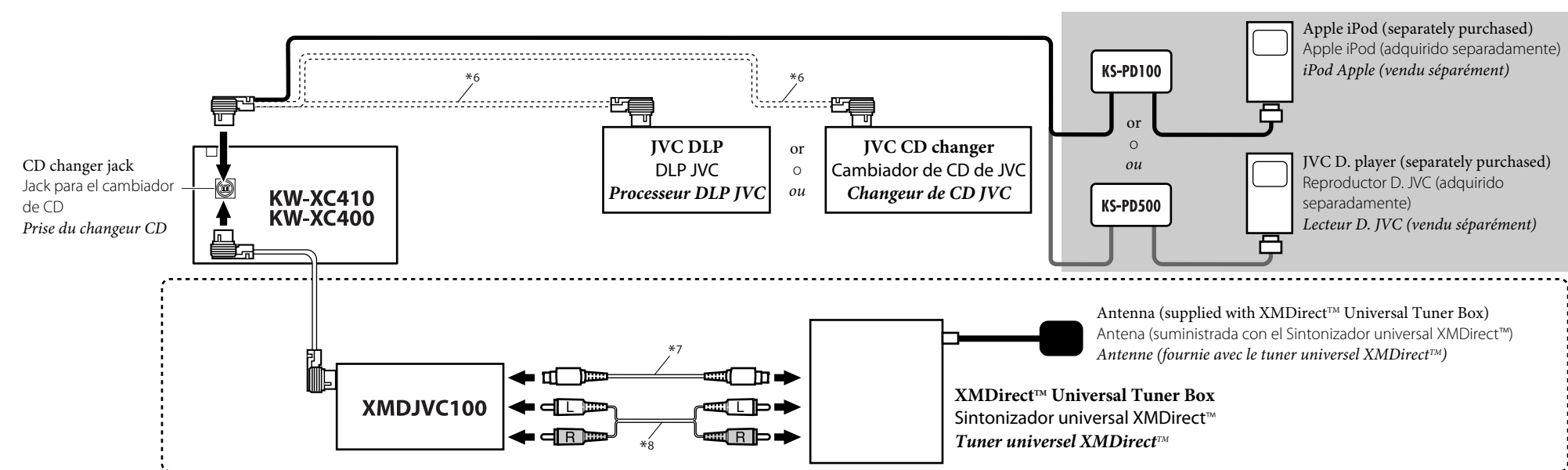
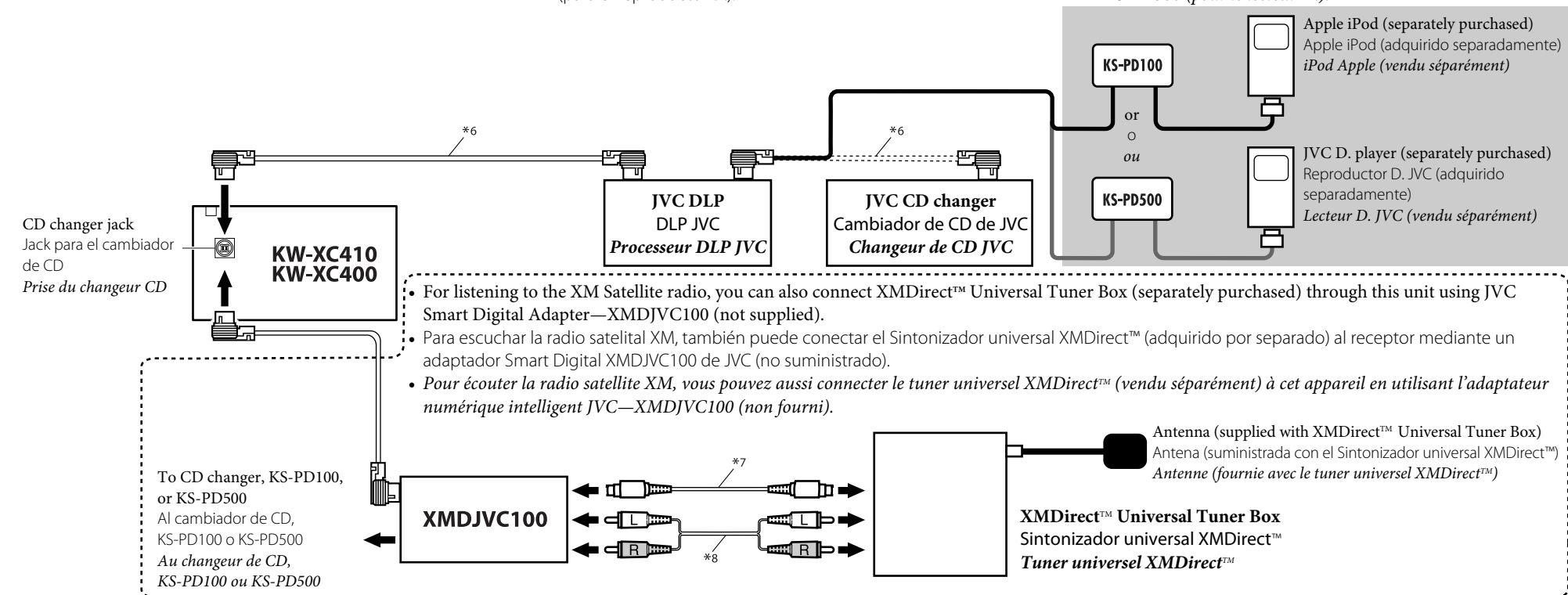

#### CAUTION / PRECAUCION / PRECAUTION:

- Before connecting the external components, make sure that the unit is turned off.
- Antes de conectar los componentes externos, asegúrese de que la unidad esté apagada.
- Avant de connecter les appareils extérieurs, assurez-vous que l'appareil est hors tension.

- \*5 iPod is a trademark of Apple Computer, Inc., registered in the U.S. and other countries.
- \*5 iPod es una marca comercial de Apple Computer, Inc., registrada en los EE.UU. y otros países.
- \*5 iPod est une marque de commerce d'Apple Computer, Inc., enregistrée aux États-Unis et dans les autres pays.

- \*6 Signal cord supplied with your JVC CD changer or DLP
- \*6 Cable de señal suministrado con su cambiador de CD o DLP JVC
- \*6 Cordon de signal fourni avec votre changeur de CD ou processeur DLP JVC

- \*7 Signal cord supplied with your Smart Digital Adapter
- \*7 Cable de señal suministrado con el adaptador Smart Digital
- \*7 Cordon de signal fourni avec votre adaptateur numérique intelligent

- \*8 Audio signal cord supplied with your Smart Digital Adapter
- \*8 Cable de señal de audio suministrado con el adaptador Smart Digital
- \*8 Cordon audio fourni avec votre adaptateur numérique intelligent

• Set "EXT INPUT" to "EXT INPUT" (See page 22 of the INSTRUCTIONS.) / Ajuste "EXT INPUT" a "EXT INPUT" (Consulte la página 22 del MANUAL DE INSTRUCCIONES.) / Réglez "EXT INPUT" sur "EXT INPUT" (Voir la page 22 du MANUEL D'INSTRUCTIONS.)

### JVC PnP (Plug and Play) / PnP ("Plug and Play") JVC / PnP ("Plug and Play") JVC

You can also connect JVC PnP through this unit using JVC SIRIUS radio adapter, KS-U100K (not supplied).

- Turning on/off the unit can also turns on/off the JVC PnP.
- También podrá conectar la PnP JVC a través de este receptor utilizando el adaptador para radio SIRIUS JVC, KS-U100K (no suministrado).
- Al encender/apagar el receptor también se enciende/apaga la PnP JVC.
- Vous pouvez aussi connecter le PnP JVC à cet autoradio en utilisant l'adaptateur de radio SIRIUS JVC KS-U100K (non fourni).
- Mettre sous/hors tension l'autoradio peut aussi mettre sous/hors tension le PnP JVC.

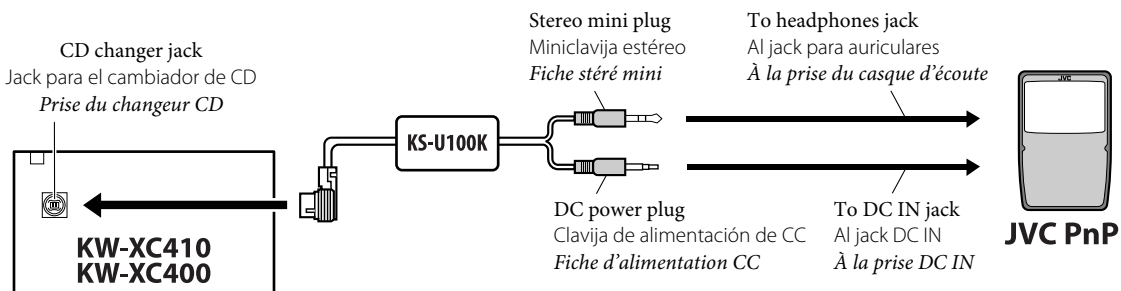

### Other external component / Otro componente externo / Autre appareil extérieur

